

# DUAL AIR FUSION PROPLACE IQ<sup>®</sup>

## OPERATOR'S MANUAL



STAHL'S  
**Hotronix<sup>®</sup>**

# Safety Instructions

## **When using your heat press, basic precautions should always be followed, including the following:**

1. Read all instructions.
2. Use heat press only for its intended use.
3. To reduce the risk of electric shock, do not immerse the heat press in water or other liquids.
4. Never pull cord to disconnect from outlet, instead grasp plug and pull to disconnect.
5. Do not allow cord to touch hot surfaces, allow heat press to cool completely before storing.
6. Do not operate heat press with a damaged cord or if the equipment has been dropped or damaged. To reduce the risk of electric shock, do not disassemble or attempt to repair the heat press. Take it to a qualified service person for examination and repair. Incorrect assembly or repair could increase the risk of fire, electric shock, or injury to persons when the equipment is used. Power supply cord must be disconnected before cleaning or servicing press.
7. This appliance is not intended for use by persons (including children) with reduced physical, sensory or mental capabilities, or lack of experience and knowledge, unless they have been given supervision or instruction concerning use of the appliance by a person responsible for their safety.
8. Close supervision is necessary for any heat press being used by or near children. Do not leave equipment unattended while connected.
9. To avoid burns, do not touch hot metal parts or the heated platen during use.
10. To reduce the likelihood of circuit overload, do not operate other high voltage equipment on the same circuit.
11. If an extension cord is necessary, then a 20-ampere rated cord should be used. Cords rated for less amperage may overheat. Care should be taken to arrange the cord so that it cannot be pulled or tripped over.
12. Keep hands clear of the upper heat press platen during lock down as the pressure may cause injury.
13. Heat press should be placed on a sturdy, suitable stand at least 24"L x 36"W x 28"H with 30" height.
14. Work area must be kept clean, tidy, and free of obstructions.

## **Important**

The Hotronix® Dual Air Fusion IQ® is equipped with a Quick Release Button located on top of the control housing. When pressed, this button activates a quick release of the heat platen when in the print position and automatically returns the platen to the UP position. Once activated, the button can be reset by pushing it in. The press will return to Normal Operating Mode.

Light on = Normal Operating Mode

Light off = Quick Release Mode

In the event of a loss in air pressure while the heat platen is in the down or print mode, disconnect the power supply (or flip power switch to the OFF position) and remove opposite lower platen. Then push the top of the Dual Air Fusion IQ® to the open position.

After air pressure has been restored, turn the heat press back on and press the yellow Shop Air Pressure icon on your screen. You may then replace the lower platen and resume printing.

# Table Of Contents

**Safety Instructions 2**

**Dual Air Fusion IQ® 4-19**



**Machine View 4**

**Operating Instructions 5-7**

- Connecting the System 5
- Start Up/Shut Down 5
- Home Screen 6
- Prepare to Print 7

**Touch Screen Guide 8-12**

- Setup Menu 8
- Password Setup 8
- Preset Setup 9
- Date & Time Setup 10
- Display Setup 10
- Auto On & Off Setup 10
- System Setup 11
- Calibration 12
- Updating Software 12

**Connecting to the IQ® Portal 13-14**

**Electrical Schematic 15**

**Dual Air Fusion IQ® 16-19  
Replacement Parts List  
& Parts Location Guide**

**ProPlace IQ® Integrated System 21-36**



**ProPlace IQ® Retrofit System 37-47**



**ProPlace IQ® 48-49  
Replacement Parts List  
& Parts Location Guide**

**Firmware Updates 51-57**

**Contact 58**

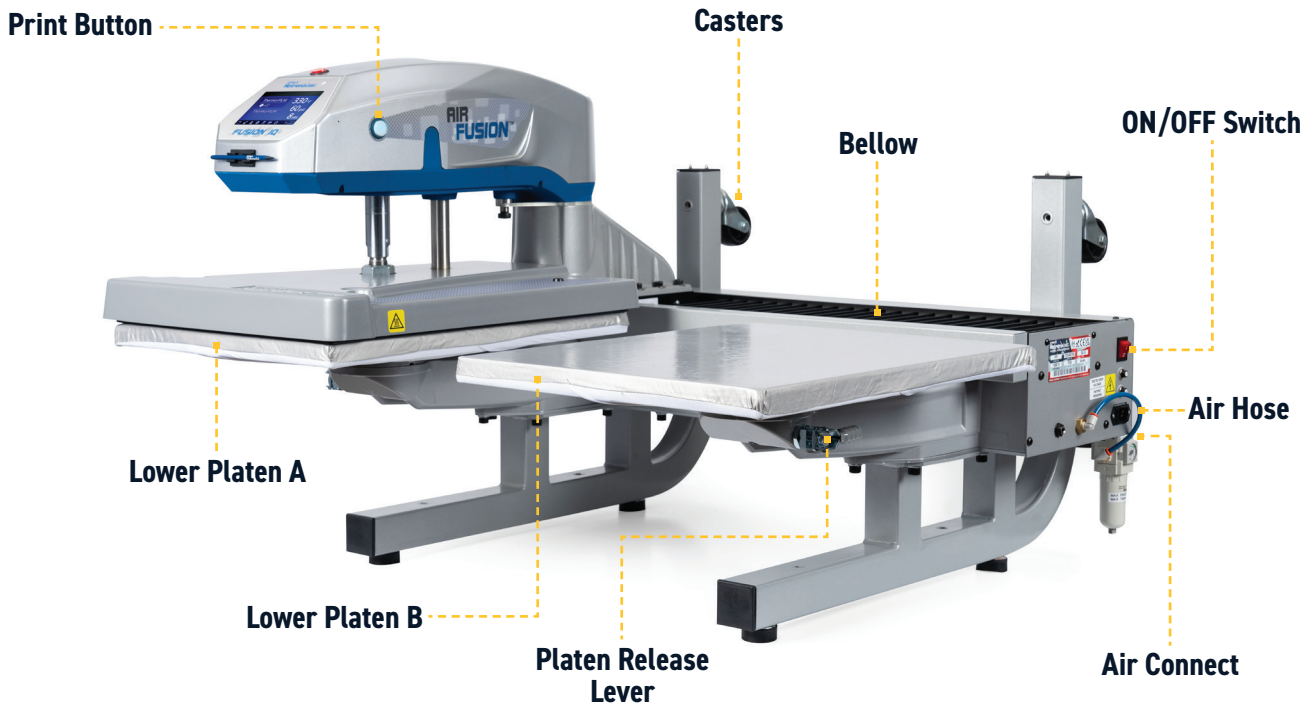

# Operating Instructions

## Connecting the System

Insert power cord into IEC inlet located on the side of press (1.1).

Connect the power cord into a properly grounded electrical outlet with a sufficient amperage rating.

### Voltage

240 volt 3500 watt presses require a full 15-amp grounded circuit.

### Extension Cords

If used, extension cords should be as short as possible and not less than 12 gauge. 10GA/20AMP rated cords are recommended.

### Circuits

Circuits that have inadequate amperage, or have other high demand equipment or appliances (especially more than one heat press) plugged in, should not be used.

**Note:** If supply cord is damaged, it must be replaced by the manufacturer, its service agent, or a similarly qualified person to avoid hazard. Use SJT type rated 300 V cord for replacement.

### Pneumatics

The air compressor used with the press should be no less than 8 gallon capacity, no less than 3.8 CFM.

The air compressor should be rated for continuous operation and with a pressure 110-120psi delivered from the compressor to the press.

Check water regulator (air filter) and shop air compressor, drain regularly to avoid pumping water into the press and damaging the EP Regulator and/or Air Cylinder.



1.1



1.2



2.1

## Start Up/Shut Down

To start up your heat press:

Flip the power switch ON (2.1). A splash screen displaying the Hotronix® logo and current software version is shown for several seconds.

To turn your heat press off, flip the power switch OFF.

To place your heat press into Standby Mode, touch and release the Power icon on the Home Screen (3.2). In Standby Mode, the heater turns off while the Touch Screen remains on, displaying an orange background as a warning if the platen is still hot (above 100°F / 38°C).

**NOTE:** Standby Mode must be used for the Auto On feature to function (10.1). The Auto On feature will not work if the power switch (2.1) is in the OFF position.

To start up your heat press while in Standby Mode, touch and release the Home icon on the Standby Screen.

## Home Screen

Displays the selected preset. Touch and hold to see application settings.

**NOTE:** Holding down material name will display targeted application settings. Screen displays current temperature, pressure, and time.

Displays multiple heat application preset step. Touch the empty circled numbers to switch between preset steps.

Touch and edit your favorite presets.

Lock the screen (Manager-level only) to prevent User-level operators from changing settings.

Touch and edit Users to control operator access level and track press usage by operator in the IQ® Portal.

Touch Setup Menu.

Touch to toggle tack mode.

Touch to cycle through Shuttle modes.

Place press in Standby Mode to take advantage of the scheduled Auto On feature.

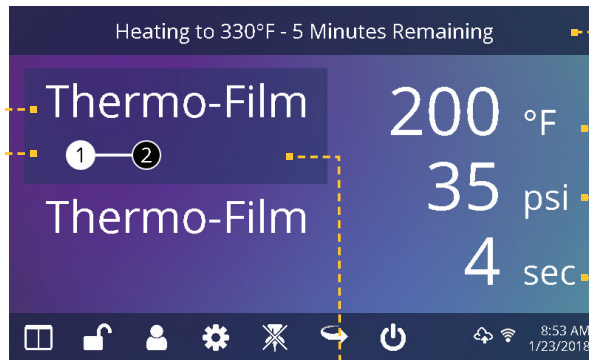

3.1

Highlighted preset represents the active platen; top is A, bottom is B.

Status bar provides helpful information regarding heat press.

Displays the current application temperature and time. To view pressure, touch 0 and target pressure is displayed. Manual pressure adjustment required.

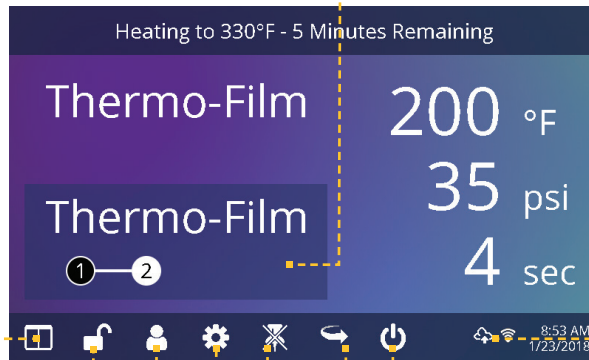

3.2

IQ® Portal and WIFI connection status.

# Operating Instructions

## Prepare to Print

### Entering Application Settings

Before you begin heat applying, verify the appropriate application settings are entered for both lower platens. Application settings for lower platen A and platen B are stored separately.

To enter application settings for lower platen A, the upper platen must be in the A position. If it is in the B position, depress the foot pedal (4.2) while the Auto Shuttle function is enabled (3.2) to shuttle to A position.

Select a preset material application (7.1) for the A position or manually enter temperature, pressure and time based on transfer material instructions.

Shuttle the upper platen to the B position using the foot pedal (4.2).

Select a preset material application (7.1) for the B position or manually enter temperature, pressure and time based on transfer material instructions. For best results, temperature settings for A and B positions should match.

### Basic Printing

Position the garment and design.

Shuttle the upper platen over the garment and design using the foot pedal.

Press both Print Buttons located on the side of the press.

The upper platen will lower into PRESS position. The timer will automatically begin to count down.

When the Print Cycle is complete, the top platen will return to the UP position.

**CAUTION:** When Auto Shuttle mode is enabled (Arrow icon), the upper platen will automatically shuttle to the opposite platen.

If a second application is desired, repeat previous steps.

### Shuttle and Tack Modes

Touch the Shuttle icon (3.2) to cycle through three shuttle modes:

- Auto: shuttle automatically after each Print Cycle or when the foot pedal is pressed
- Foot pedal: shuttle only when the foot pedal is pressed
- Off: air-operated shuttling is disabled and the controller housing must be shuttled by hand.

The Print Cycle will not begin unless the upper platen is in either the A or B position.

**NOTE:** Auto Shuttle can be disabled for individual preset stages (7.6) for a heated post-cure effect.

Touch the Tack Mode icon (3.2) to toggle ON/OFF. Tack mode is useful for experimenting, fine-tuning print recipes or very brief application times.

- Tack Mode On: press and hold both Print Buttons to start Print Cycle. Print Cycle completes when buttons are released
- Tack Mode OFF: press and hold both Print Buttons to start Print Cycle. Print Cycle completes when countdown timer reaches 0.

Pressing the print buttons a second time during the print cycle will interrupt it.

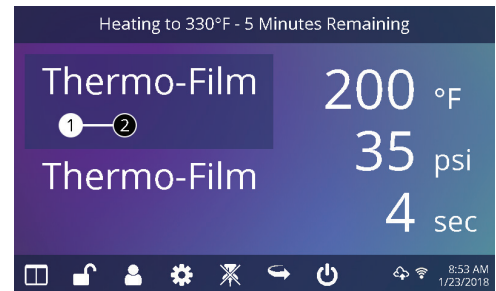

4.1



4.2

## Setup Menu

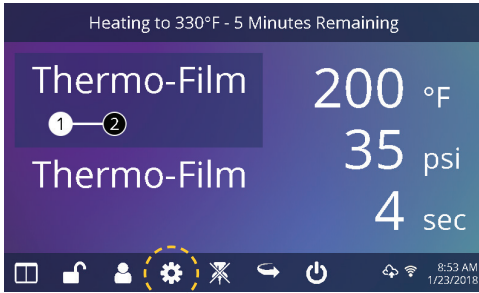

5.1

Touch the Settings icon on the Home Screen (5.1) to configure your heat press.

Managers can access all setup options, while Users can access a limited set (5.2).

- Managers default password: M

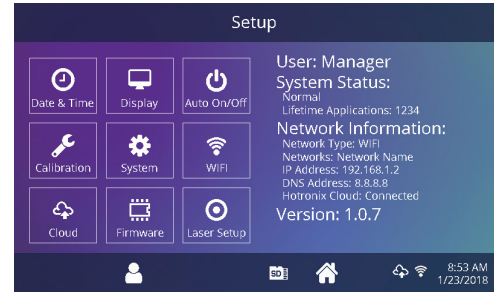

5.2

## Password Setup (Manager Level Only)

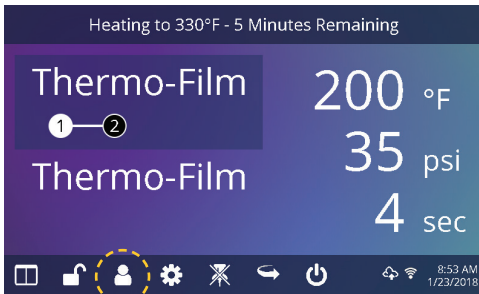

6.1

Touch the User icon on the Home Screen (6.1) or Setup Menu (6.2) to select, add, and edit Users.

Touch and edit Managers and Users to configure access to settings (6.3, 6.4). Heat press reports on the IQ® Portal can be filtered by User to track individual operator performance.

Touch the arrow keys on the taskbar to scroll through a long list of Users (6.5).

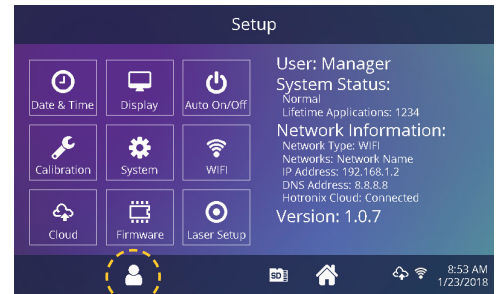

6.2

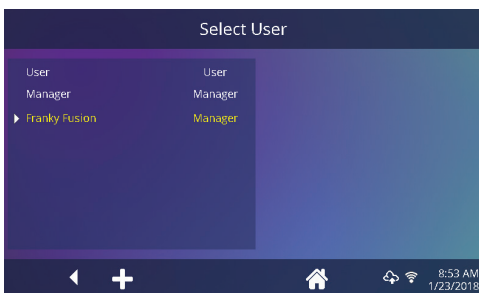

6.3

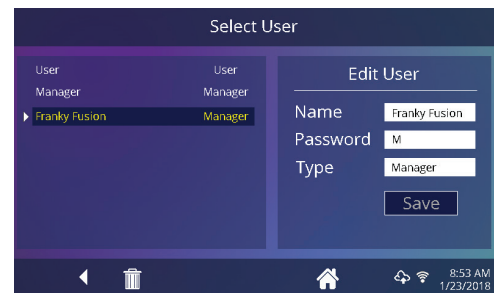

6.4

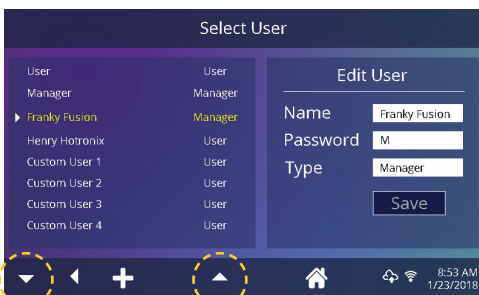

6.5



# Touch Screen Guide

## Preset Setup

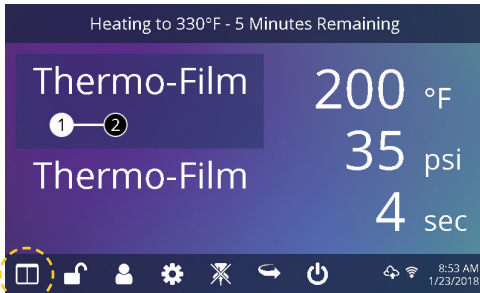

7.1

Touch the Columns icon (7.1) to select from a list of saved presets (7.2).

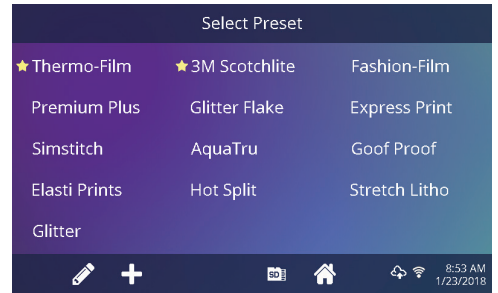

7.2

Touch the arrow keys on the taskbar to scroll through a long list of presets (7.3).

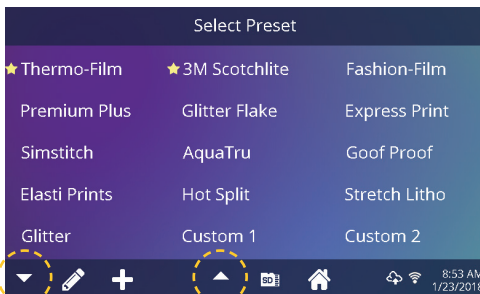

7.3

Touch a preset to select a material. The preset selection is applied to the active platen.

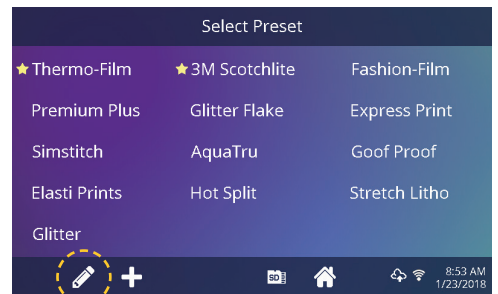

7.4

Touch the Pencil icon (7.4) to enter edit mode, then touch preset name to edit settings. Touch Enter to save changes.

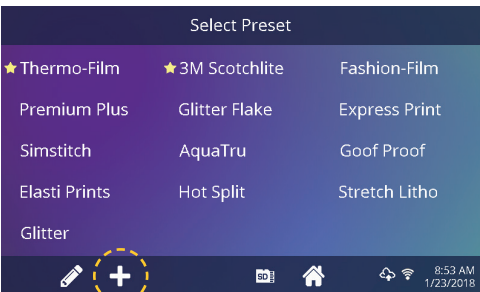

7.5

Touch the Plus icon to create a new preset (7.5).



7.6

Name your preset and enter desired temperature, time, and pressure. When creating a new preset, the current Home Screen application settings are selected automatically (7.6).



7.7

Touch the empty circled numbers to set multiple preset stages for pretreatment or multi-step applications (7.7).

Auto Shuttle can be disabled on individual preset stages for a heated post-cure useful in some applications, including Direct-To-Garment printing. This setting will override Shuttle settings on the Home Screen (3.2).

## Date & Time Setup

Touch the Settings icon on the Home Screen.

- Touch Date & Time, information displays on right of screen (8.1).
- Touch up/down arrows to select time zone.
- Touch Auto to automatically synchronize the heat press clock.  
The heat press must be connected to a WIFI network with access to the Internet.
- Touch Daylight Saving to enable daylight saving mode.

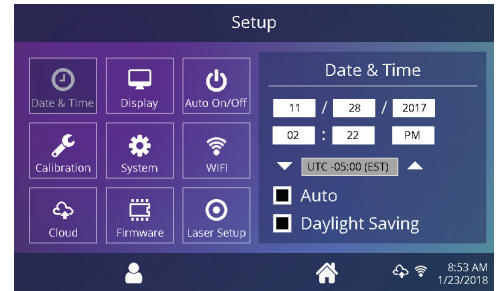

8.1

## Display Setup

Touch the Settings icon on the Home Screen.

- Touch Display, information displays on right of screen (9.1).
- Touch Temperature to switch between F° or C°, then touch Check Mark icon on taskbar to save.



9.1

## Auto On & Off Setup

Touch the Settings icon on the Home Screen.

- Touch Auto On/Off, information displays on right of screen (10.1).
- Touch Enable, then On Hour/Minute and Off Hour/Minute, selecting Enter between each setting. Once entered, touch Check Mark icon on taskbar to save.

**NOTE:** Standby Mode must be used for the Auto On feature to function (3.2).  
The Auto On feature will not work if the power switch (2.1) is in the OFF position.

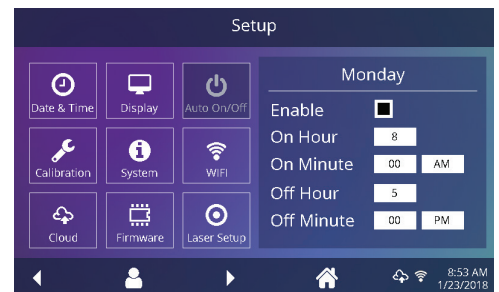

10.1

# Touch Screen Guide

## System Setup (Manager Level Only)

Touch the Settings icon on the Home Screen.

- Select System, information displays on right of screen (11.1).
- Touch Power Save and select time, then touch Check Mark icon on taskbar to save.
- When enabled, your heat press will enter Standby Mode if it is not used for the specified number of hours.
- Select Target Temp. Press both buttons to lower heat platen. Heat press will not count down until it reaches setting temperature.
- Change Shuttle Delay, time will result in a delay for Shuttle after heat printing completes.



11.1



### Calibration (Manager Level Only)

Your heat press comes pre-calibrated from the factory. Calibration is only required after sensor or controller replacement. Incorrect calibration can result in poor print results or damage to your heat press which is not covered by warranty.

All Fusion IQ® heat presses have a temperature calibration function (12.1).

- Turn on heat press and heat to 350°F/177°C.
- Place temperature strip on center of platen and press for 5 seconds, or measure center of heater with contact thermocouple (not infrared) thermometer.
- Touch the Settings icon on the Home Screen.
- Touch Calibration, information displays on right of screen.
- Touch Temperature and adjust Temperature Calibration to match Target Temperature.

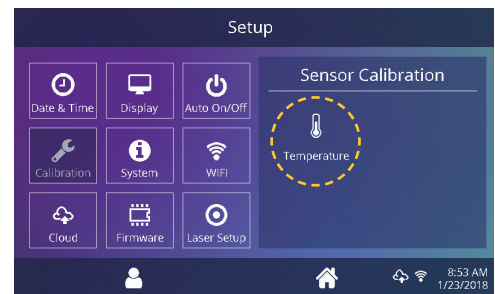

12.1

### Updating Software

Touch the Settings icon on the Home Screen.

- When a software update is available, an exclamation point appears after the version number in the Setup Menu.
- Touch Firmware, information displays on right of screen. An available online update displays a cloud icon (13.1).
- Touch Update File on right of screen, then touch Check Mark icon on taskbar to start download. A downloaded update displays a memory card icon.
- Touch Downloaded Update File on right of screen, then touch Check Mark icon on taskbar to start installation.

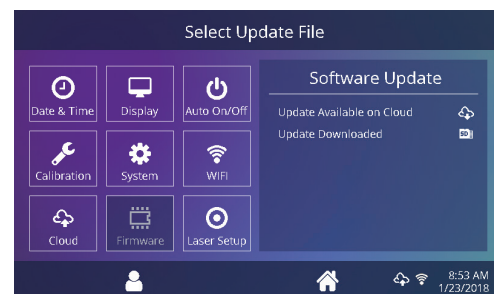

13.1

**NOTE:** If a power failure occurs during installation, the heat press will attempt to install the previous software version.

# Connecting to the IQ® Portal

## Create Your Account

- Using a phone or computer, visit [iq.hotronix.com](http://iq.hotronix.com) to create an account (14.1).
- Enter your name, email, and password.
- Click on the confirmation link in the email you receive.
- Your account has been created.

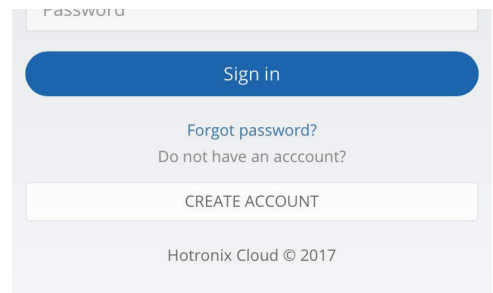

14.1

## Register a Heat Press

- Click on Manage Heat Presses, then New Heat Press.
- Select heat press type, enter serial number, and enter a name for the heat press (optional).
- Click on Create Heat Press and enter the verification code given.
- On the heat press Setup Menu, touch WIFI and connect to your WIFI router or mobile hotspot (14.2).
- On the heat press Setup Menu, touch the Cloud icon and enter the verification code displayed in the IQ® Portal (14.3).
- Your heat press has been registered.



14.2

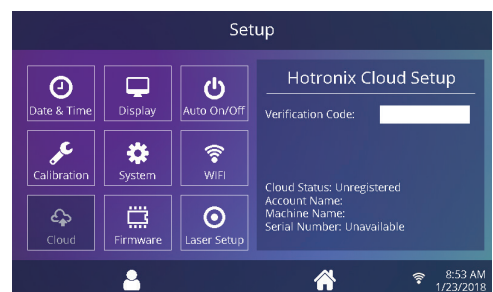

14.3

### Create & Assign Users

- Click on Manage Operators, then New User.
- Enter a name and select a privilege level. Managers can access all heat press settings while Users have limited access.
- Click on New User, then Assign Machines in the sidebar.
- Select a machine and click Assign.
- On the heat press Setup Menu, touch the Cloud icon, then Manual Sync (14.4).
- Reporting will show impressions made by the Users.



14.4



# Electrical Schematic

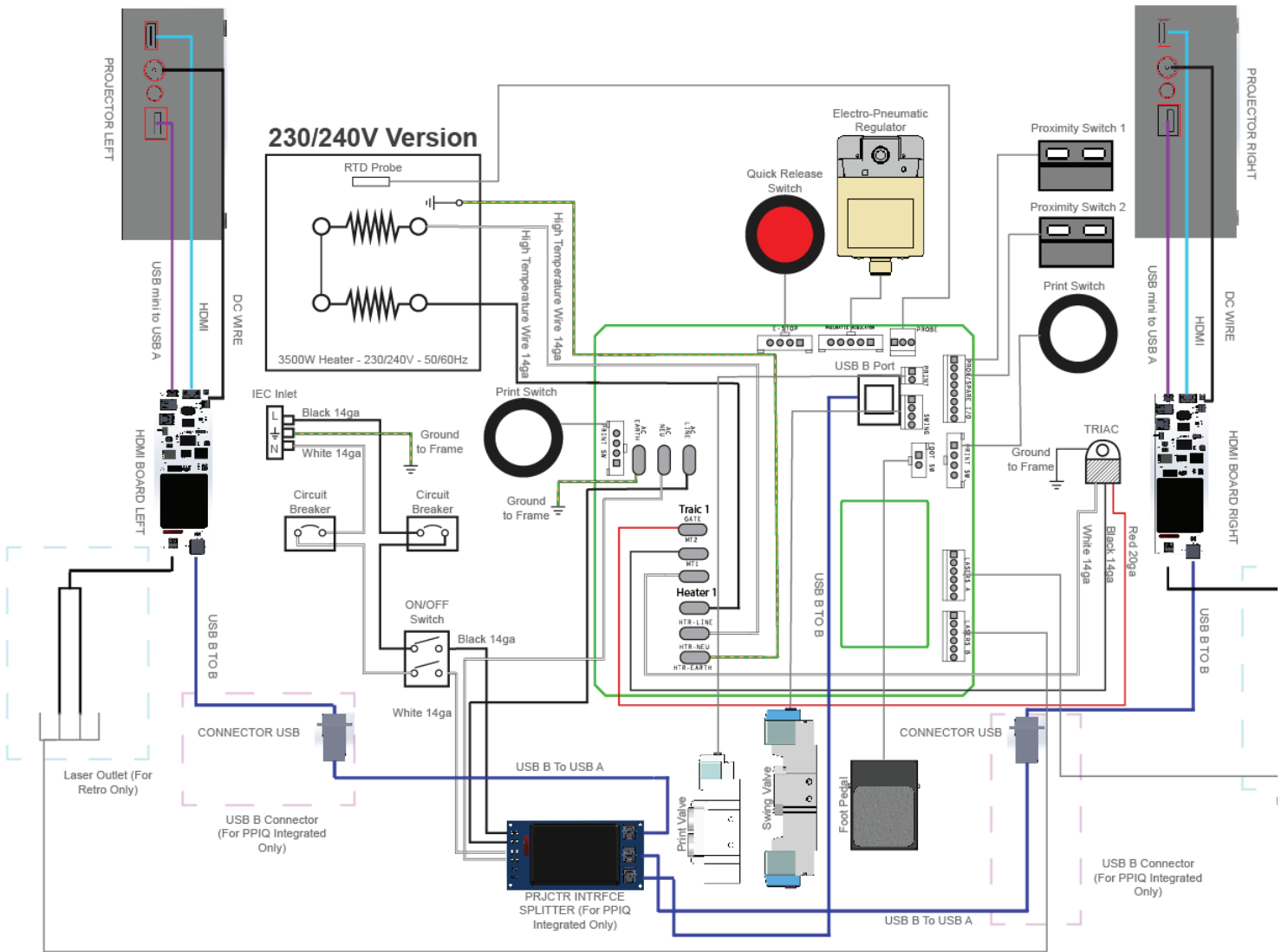

ITEM #	PART NAME	PART #	QTY
1	Air Fusion Control Housing	1-2197	1
2	Button, White, Print Switch	1-2319	2
3	Button, Red, Quick Release	1-2270	1
4	Fusion IQ Power Board	1-2664-P	1
5	Fusion IQ Power Bracket	1-2473	1
6	Screw, Sheet Metal #6 x 1/2"	3-1011-235	6
7	Fusion IQ Latch	1-2474	2
8	Spring, 1/4" x 1", 1.7lbs/in	1-2485-1	2
9	Fusion IQ Controller	1-2664-F	1
10	Fusion Overlay NextGen	1-2198-1	1
11	Cap, Plastic Black 1/2"	1-1971	2
12	Touchscreen Stylus Holder	1-2386	1
13	Touchscreen Stylus	1-2385	1
14	Power Switch Cover Plate	1-2422	1
15	Screw, Machine #6-32 x 1/2"	3-1011-19	6
16	Nut, #6-32 Hex with Lockwasher	2-1006-50	12
17	Chevron Cover Plate	1-2423	1
18	Screw, Machine #8-32 x 3/4"	3-1011-155	4
19	Air Fusion Upper Casting	3-1341	1
20	Bushing, Flange 1in	1-2282	1
21	Dual Fusion Bearing Spacer, 3/16"	1-2396	6
22	Dual Fusion Bearing Spacer, 1/4"	1-2397	2
23	Spanner Nut 2in-18	2-1006-95	1
24	TRIAC	1-2464-1	1
25	Air Cylinder 6in	1-2264	1
26	Washer, 1in Nord-Lock	2-1006-94	1
27	Nut, Hex 1"-12	2-1006-96	1
28	Dual Fusion Heater Spacer	—	1
29	Screw, Button Socket Head 5/16"-18 x 1	3-1011-104	6
30	Air Fitting, Elbow 1/4" NPT x 1/4" Tube	4-1015-12	5
31	Screw, Machine #10-24 x 5/8	3-1011-217	4
32	Washer, Plastic Finishing	1-1063	4
33	Air Fusion Heater Cover	1-2263	1
34	Insulation 16 x 20	1-2256	1
35	C-Clip	1-2286	1
36	Guide Tube, XRF & XRF2	1-2290	1
38	Screw, Socket Head 3/8"-16 x 5/8	3-1011-64	1
39	Screw, Socket Head 5/16"-18 x 3/4"	3-1011-100	4
40	Screw, SS Phillips #8-32 X 1/4"	3-1011-87	4
42	Thermostat Disc	1-2076	1
43	Screw, SS Sheet Metal #4 X 1/4"	3-1011-98	2
44	Temperature Probe	1-1272-1	1
45	Heat Platen 16 x 20 3500W Milled (No Ears)	2-1002-3-HW	1
46	Screw, Socket Head Cap Low Profile 1/4-20 X 1/2"	3-1011-261	4

ITEM #	PART NAME	PART #	QTY
47	Pneumatic Package, Dual Air Fusion	1-2269-1	1
50	Screw, Sheet Metal Hex #8 x 1/2"	1-2421	4
51	Screw, M4x0.7 x 8 Pan Phillips	1-2417	5
52	Print Valve	1-2299	1
53	Air Fitting, Straight Hex 1/4" NPT 1/4" Tube	1-2427	3
54	Air Fitting, Muffler, 1/8" NPT	1-2418	2
55	Speed Control Muffler	1-2339	1
56	Air Fitting, Check Valve, 1/4" Push-to-Connect	1-2419	1
57	Screw, Pan Phillips M3x05 x 6mm	—	2
58	Swing Valve	1-2298	1
59	Air Fitting, Elbow Restrictor #10-32 UNC 5/32" Tube	1-2428	2
60	Air Fitting, Elbow #10-32 UNF 5/32" Tube	1-2350	4
61	Electro-Pneumatic Regulator	1-2293	1
62	Air Fitting, Tee, 1/4" Push-to-Connect	1-2420	1
63	Pneumatic Regulator, Mini	1-2297	1
64	Air Fitting, Elbow #10-32 UNF 1/4" Tube	1-2430	1
65	Grommet, 5/16" ID 1/2" OD	1-2429	1
75	Dual Fusion Alignment Arm	1-2394	1
76	Press Mount Casting	1-2347	1
77	Dual Air Fusion Main Spindle	2-1670-1	1
79	Press Mount Cover	1-2393	1
80	Alignment Arm Spacer	1-2398	1
81	Press Mount Keeper Bar	1-2395	1
82	Washer, 5/16" Flat SAE Zinc	2-1006-91	10
83	Screw, Socket Head 1/4"-20 x 3/4"	3-1011-106	10
84	Screw, 5/16"-18 x 1-1/8" Socket Head Cap	3-1011-20	10
85	Screw, 5/16"-18 x 5/8" Flat Socket Head Cap	3-1011-277	6
86	Screw, 3/8"-16 x 1" Socket Head Cap	3-1011-276	1
87	Screw, Machine #8-32 x 1/4"	3-1011-81	18
88	Platen, 16x20	2-1029-HD	2
89	Silicone Pad 16 x 20 Blue	1-2136	2
90	Adapter Plate	3-1336	2
91	Quick Release Pin	1-2215	2
92	Washer, Flat 1/4" SAE	2-1006-25	14
93	Washer, Split Lock 1/4"	2-1006-44	14
94	Screw, Socket Head Cap 1/4"-20 x 1"	3-1011-191	8
105	Leg Assembly Dual	1-2345	2
111	Caster, Threaded Stem	—	4
112	Rubber Foot	1-2575	4
113	End Cap, Dual Fusion Leg	1-2349	2
115	Plastic Square End Cap, 2in	Kit 1-2345	2
116	Washer Split Lock 3/8"	2-1006-43	18
117	Screw, Socket Head Cap 3/8"-16 x 1"	3-1011-43	18
118	Screw, Set #8-32 x 3/8"	—	8



# Parts Location Guide

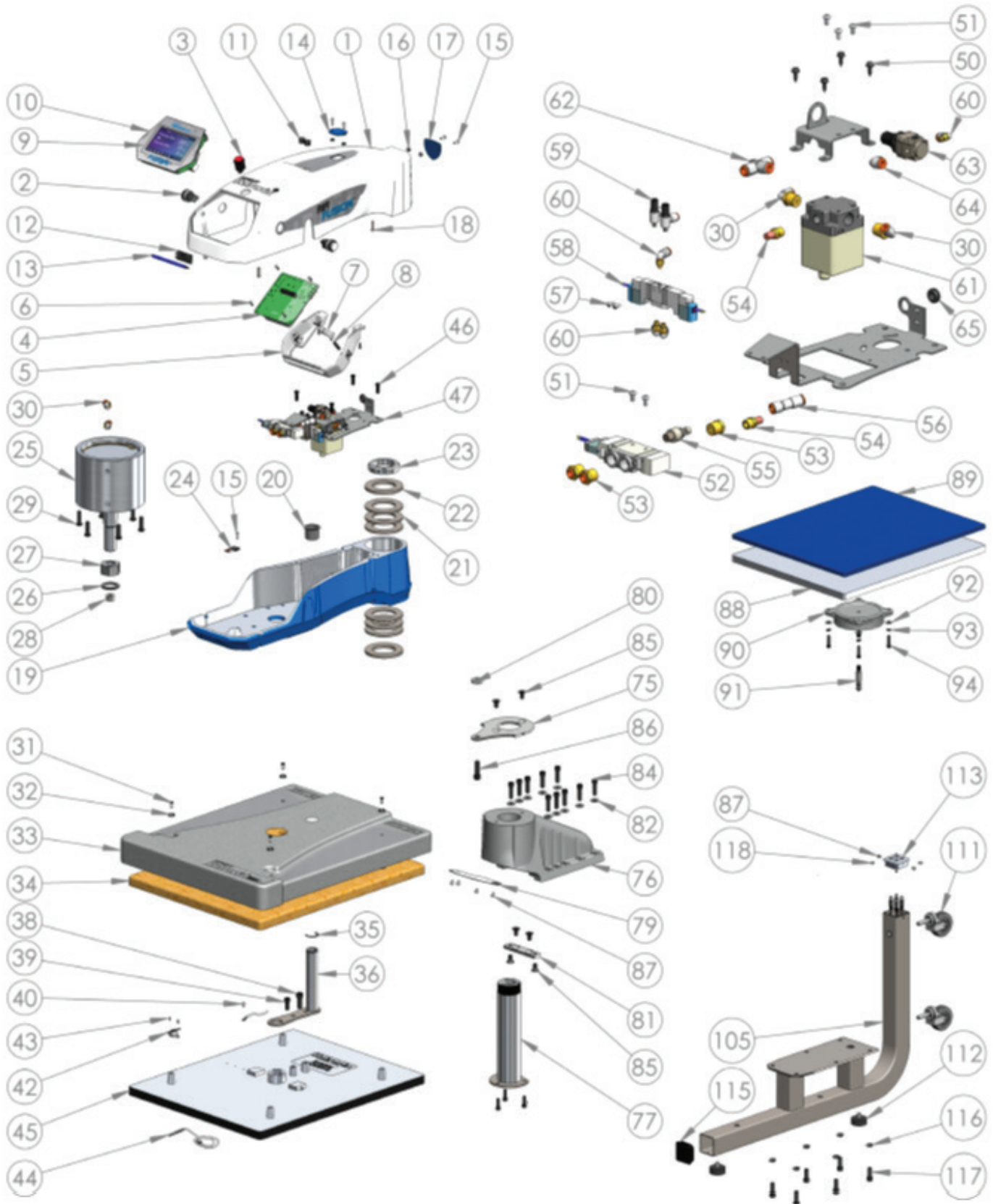

ITEM #	PART NAME	PART #	QTY
119	Dual Fusion Regulator Mount	—	1
120	Air Filter & Regulator	1-1215	1
121	Curtain Bellows	1-2335	2
123	Carriage Plate Keeper	1-2342	2
124	Back Cover (Part of Tin Assembly)	Kit 1-2340	1
125	Front Cover (Part of Tin Assembly)	Kit 1-2340	1
126	End Stop Plate	—	2
127	Proximity Magnet	1-1219	4
128	Dual Fusion Base Casting	4-1176	1
129	Rail and Block Rear, XRF2	1-2336-1	1
130	Rail and Block Front, XRF2	1-2336-2	1
131	Base Plate	—	1
132	Right Base Cover (Part of Tin Assembly)	Kit 1-2340	1
133	Air Fitting, 1/4" ARO Male Coupling 1/4" NPT	1-1788	1
134	Air Cylinder Rodless	1-2338	1
136	Quick Release Clamp, Fusion	1-2332-1	2
137	Silicone Damper	1-2424	2
140	Cable Carrier	1-2337	1
141	Left Base Cover (Part of Tin Assembly)	Kit 1-2340	1
142	Base Access Plate (Part of Tin Assembly)	Kit 1-2340	1
143	Foot Pedal Socket (Part of Foot Pedal Assembly)	Kit 1-2305	1
144	Air Fitting, Elbow Bulkhead 1/4" Tube	—	1
149	Screw, Machine #8-32 x 1/2"	3-1011-159	4
150	Screw, Button Head Socket 1/4"-20 x 5/8"	3-1011-241	8
151	Screw, Machine #6-32 x 1/4"	3-1011-25	4
152	Nut, Hex #8-32 w/ Tooth Washer	2-1006-52	8
153	Screw, Machine #4-40 x 3/8"	3-1011-22	12
154	Screw, Machine #8-32 x 3/8" Black Oxide	3-1011-127	6
155	Screw, Socket Head 1/4"-20 x 1-3/4"	3-1011-194	6
156	Screw, Socket Head M4 x 20mm	3-1011-268	38
157	Power Inlet and Filter, 20A	1-2490	1
158	Power Switch	1-2087	1
162	Circuit Breaker 20A (STX XF XRF)	1-1331-3	2
163	Dual Fusion Carriage Plate	1-2344	1
167	Drive Angle	1-2341	2
168	Screw, Socket Head Cap Low Profile 1/4-20 x 1/2"	3-1011-261	4
169	Hard Stop	1-2343	2
170	Dual Fusion Magnet Bracket	1-2425	2
171	Screw, Machine #4-40 x 1/4"	3-1011-278	2
172	Proximity Switch	1-1211-1	2
173	Nut, #4-40 with Tooth Washer	2-1006-51	4
174	Screw, Socket Head M5 x 15mm	3-1011-263	16
175	Foot Pedal Assembly	Kit 1-2305	1
178	Power Cord C19 250V	1-2353	1

# Parts Location Guide

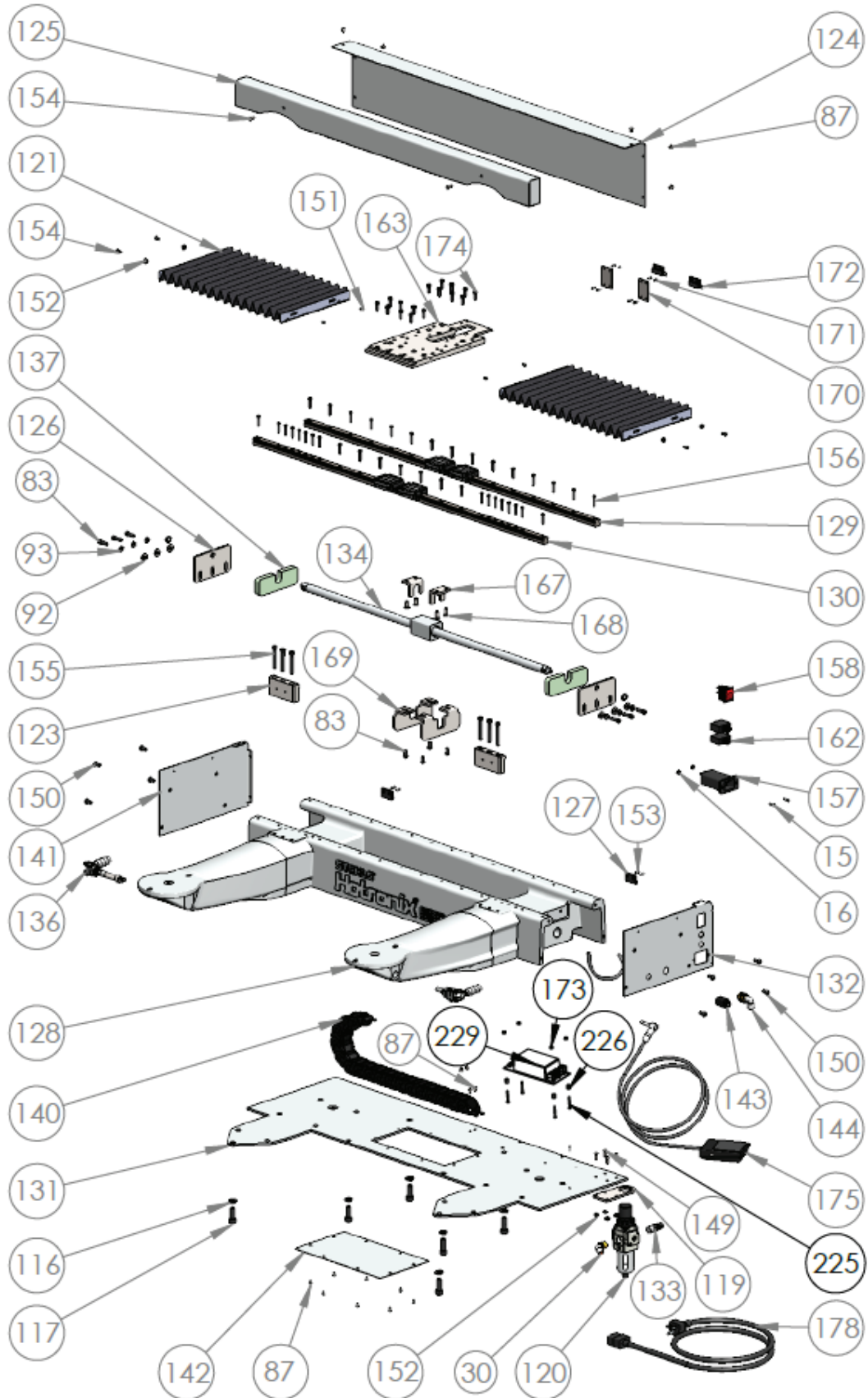



# PROPLACE IQ<sup>®</sup>

## Integrated System



**ProPlace IQ<sup>®</sup> Integrated System** 21-36

**Assembly Instructions** 22-26

**Initial Setup** 27-28

**Operating Instructions** 29-33

Basic Terminology 29

**Cloud Operations (WIP)** 34-36

Upload and Download 34-35

Calibrating the Image 36



# HOTRONIX® PROPLACE IQ® INTEGRATED

- 1** Open the back panel unfastening 4 screws using the screwdriver (15.1).



15.1

- 3** Slide the tube into the channel as shown here (15.3).

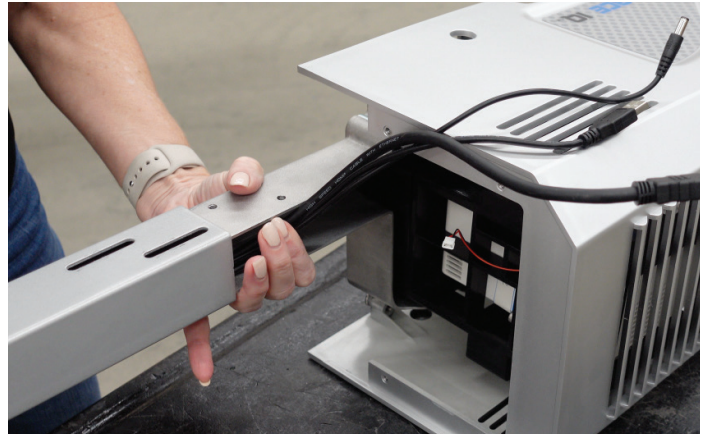

15.3

- 2** Carefully disconnect the fan connector to open the back panel completely (15.2).

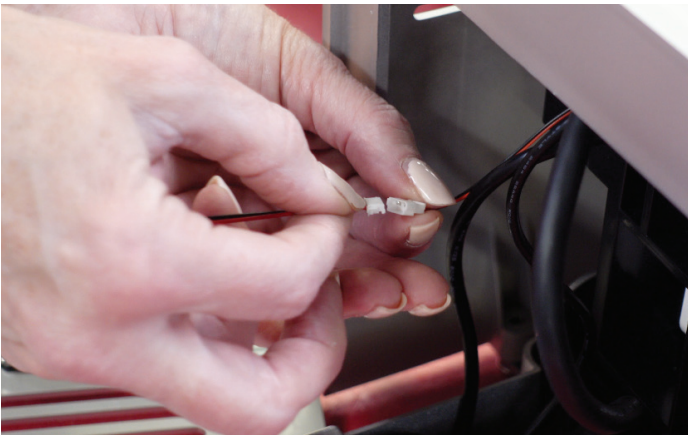

15.2

- 4** Connect the USB, HDMI, and power cables (x3) protruding out of the tube to the projector (on the accessible height) (15.4).

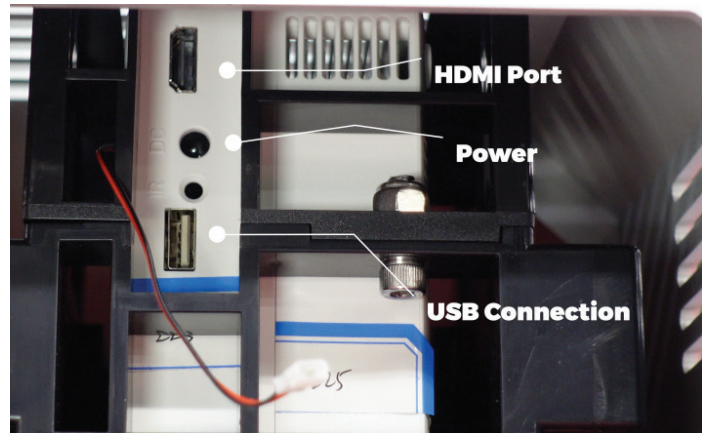

15.4

# Assembly Instructions

**5** NOTE: Ensure the connections are tight (15.5).



**15.5**

**7** Close the back panel using 4 screws using the screw driver (15.7).



**15.7**

**6** Reconnect the fan wire to the connector. Note: Ensure to follow the order of the cable by matching the color of the wires (15.6).



**15.6**

**8** Loosely fasten the bolts (x4) to hold the tube and the projector head assembly together. (The bolts will be adjusted in the later step aligning the projector to the platen.) (15.8)



**15.8**

# HOTRONIX® PROPLACE IQ® INTEGRATED

**9** Take one end of the USB-B cable out of the tube gently. The other end has to remain plugged in to the PI board (15.9).



15.9

**11** Plug in the USB-B wire to the connector plug (15.11).



15.11

**10** Have someone hold the projector assembly in place (15.10).



15.10

**12** Align the tube with the bottom channel and place the tube sliding into the channel. \*\*Ensure the USB-B cable doesn't get pinched between the tubes\*\* (15.12)



15.12



# Assembly Instructions

**13** Place the washer and fasten the bolts on both the sides of the tube using the supplied wrench (15.13).



**15.13**

**16** Carefully slide the support bracket connecting the tubes so that the washer and the bolts hold the support bracket (15.15).



**15.15**

**17** Fasten the bolts (x2) on both the tubes holding the support bracket in place using the supplied wrench (15.16, 15.17).



**15.16**

**14** Repeat steps 1 through 13 on the other side (tube and projector assembly).

**15** Place the washer and loosely fasten the bolts (1 on each side) on the outer side of the tube (15.14).



**15.14**



**15.17**

**18** Peel the protective film out from both the sides of the transparent cover (15.18, 15.19). **NOTE:** Before installing the transparent cover, make sure the focus is adjusted on both projectors as outlined in the Initial Setup section on pages 27-28, then complete steps 19-20.



**15.18**



**15.19**

**19** Slide the transparent cover through the slot on the side of the housing. Ensure it rests completely on the ribs of the housing all the way until it rests on the ribs on the other side (15.20, 15.21).



**15.20 Transparent Cover**



Transparent Cover Resting on Rib  
Slot for Transparent Cover

**15.21**

**20** Align the holes in the transparent cover with the holes on the lip of the mounting base and fasten the two using 8-32 thumb screw (qty. 2) and using fingers (15.22, 15.23).



**15.22 Aligning the Holes**



**15.23**

# Initial Setup

**1** Turn on the machine to adjust the focus on both the projectors ensuring crisp image. To adjust the focus, just turn the lens on the right side of the projector when viewed from the front of the machine (16.1, 16.2).



16.1



16.2

**2** Ensure that the source on the projector is set to HDMI (topmost function from the dropdown) by default when you turn the projector on for the first time for HDMI and Cloud functionality. Use inbuilt remote function to change it (if needed) (16.3, 16.4).

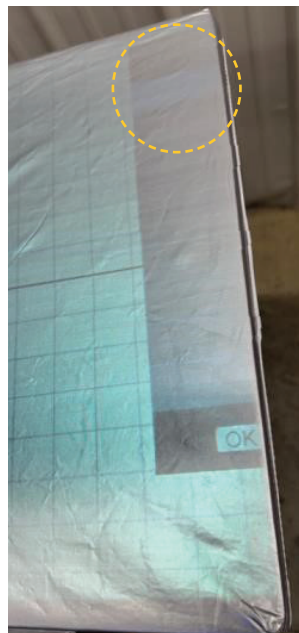

16.3 HDMI Source Selected

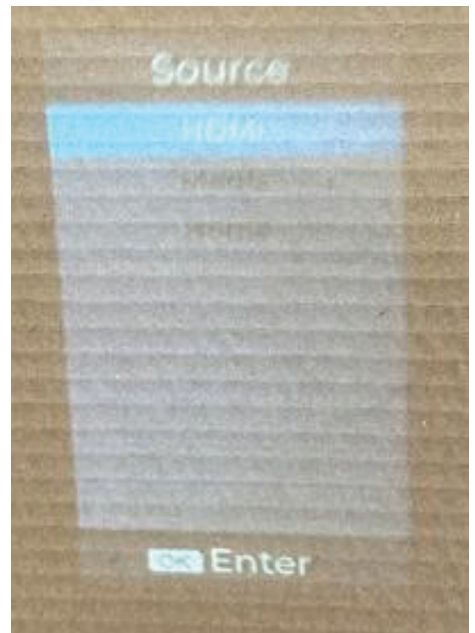

16.4

**3** On the Fusion IQ home screen, select the preset selection window icon (left bottom) (16.5) and then choose the projector icon on the bottom center (16.6). Select the remote icon on the bottom to open the on screen remote (16.7). Select the gear icon to change the source on the projector (16.8).



16.5



16.6

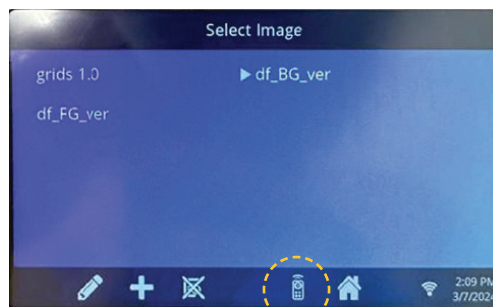

16.7

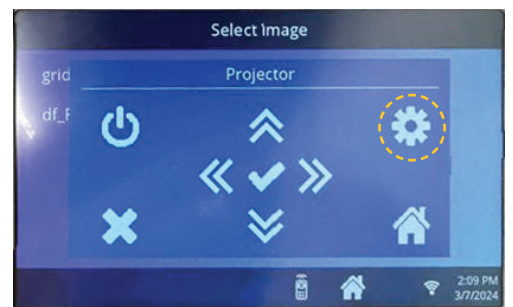

16.8

**4** On the Fusion IQ home screen, select the preset selection window icon (left bottom) (16.9) and then choose the projector icon on the bottom center (16.10). Select the remote icon on the bottom to open the on screen remote (16.11). Select the home icon to go to menu on the projector (16.12).



16.9



16.10

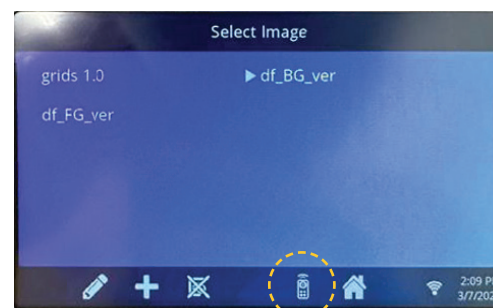

16.11

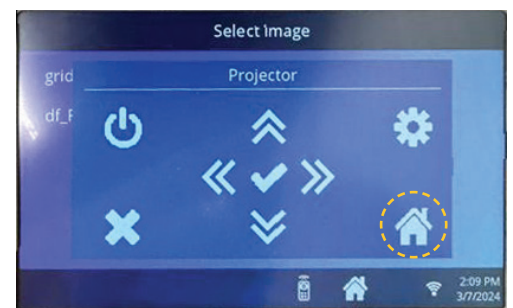

16.12

# Operating Instructions

## Basic Terminology

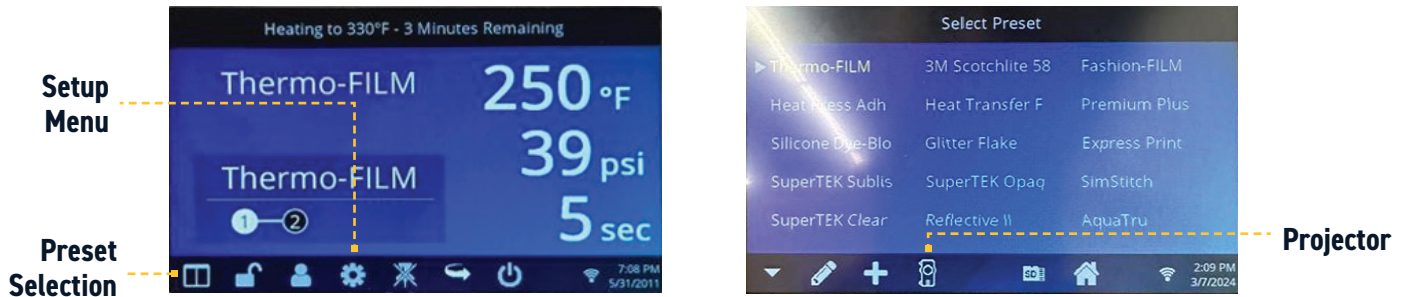

**1A Initial Check:**  
 Touch the setup menu on the home screen (17.1) and touch system. Ensure that the “Projector” is checked, and “Network” is selected (not retro), and the projector icon is visible on the right bottom (17.2). NOTE: If the “Projector” Icon is not checked, check the box, touch “check mark” on the center bottom and then user will be asked to restart the system by selecting “Yes” (17.3).



17.1 Setup Menu

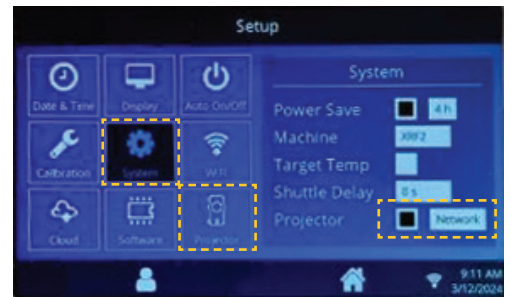

17.2 Projector and Network “Checked”



17.3

**1B** Touch the setup menu in the home screen and then touch the projector icon on the bottom right. Ensure that the FusionPI - A and B shows a projector icon next to them. This will ensure that the PI boards are working correctly (17.4).



17.4

## 2 Image Selection:

Touch the preset selection window icon on the left bottom (17.5) and then touch the projector icon on the center bottom (17.6) to enter the image selection screen. Select the desired image from the available image list (17.7). NOTE: Once you select an image, the Fusion IQ will go back to the home screen, and you must repeat the above step to select a different image.

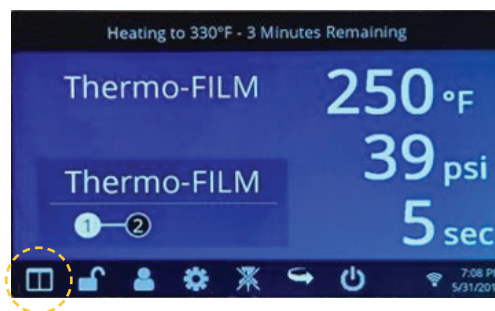

17.5 Preset Selection

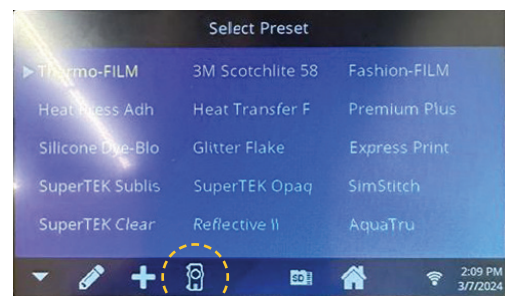

17.6 Projector

## 3 Preview Mode:

To preview the image (not select it), touch the preview icon on the center bottom in the image selection screen (17.8). This will project the image for ~1 minute and then go back to the previous image that was being projected. NOTE: When an image is chosen for preview, the user will see the chosen image highlighted and the selected image will still have the arrow beside it implying the image is selected and the user will see that image back after ~1 minute (17.9).

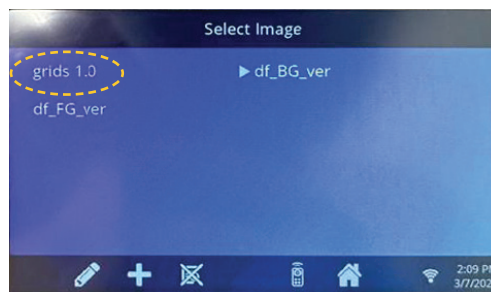

17.7 Image Selection Screen

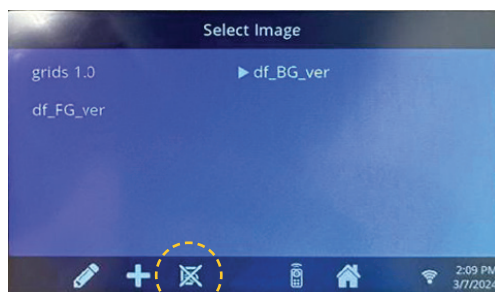

17.8 Preview Mode Off



17.9 Preview Mode On

# Operating Instructions

## 4A Import Image Using SD Card:

Pop out the front face carefully by inserting a paper clip in small holes on both the side of the fusion cover. Disconnect the front face carefully from the power board (17.10). Take out the SD card from the fusion IQ board (17.11).



17.10

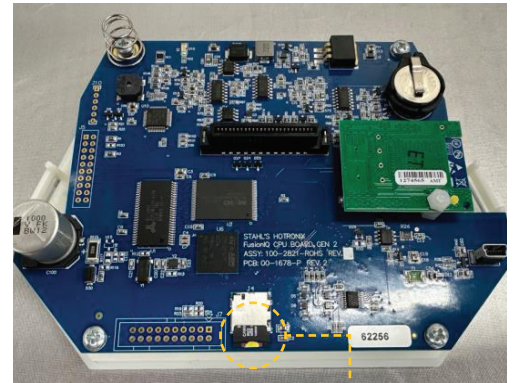

17.11

SD Card

4B Plug in the SD card to a computer, go to the "SmartPress" folder and upload the desired images to the "Images" folder (17.12).

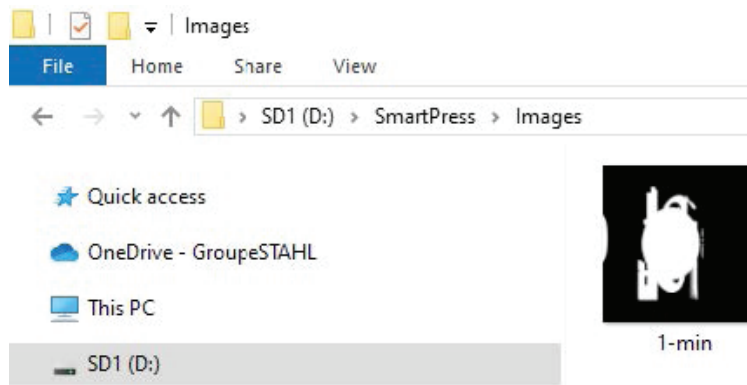

17.12

4C Plug in the SD card back to the Fusion IQ board and carefully plug the Fusion IQ board to the power board. Turn on the machine. On the Fusion IQ home screen, click on the "Preset Selection" (17.13) and then select projector icon (17.14) to open the image selection screen.



17.13 Preset Selection



17.14 Projector

# HOTRONIX® PROPLACE IQ® INTEGRATED

**4D** Select “+” to add the desired image/s (17.15). Enter a name on the “Name” tab and then click on the “File Name” tab to open the list of available images (17.16) (this should contain the image/s that were uploaded to the SD card using step “b”).

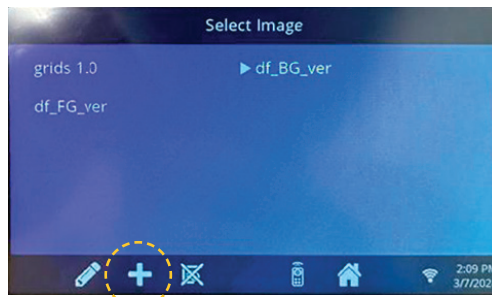

**17.15 Add Image**

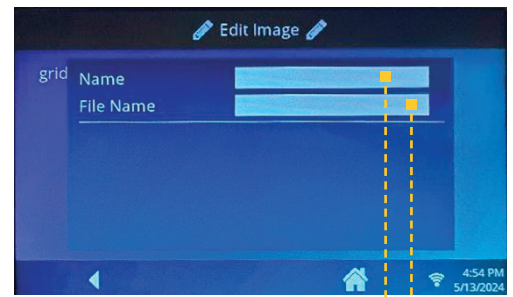

**17.16**  
**Name Tab**  
**File Name Tab**

**4E** Select the desired image from the list then click on the image (17.17) and click on “Save” (17.18) to download the image to the image selection screen (17.19) on the Fusion IQ. Select the image to project the image.

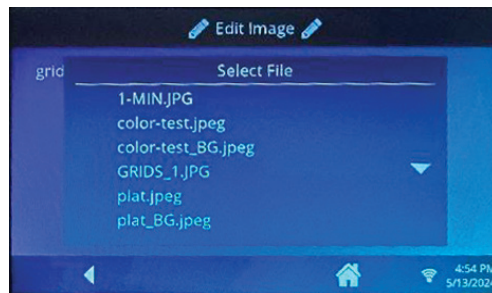

**17.17 Select Image**

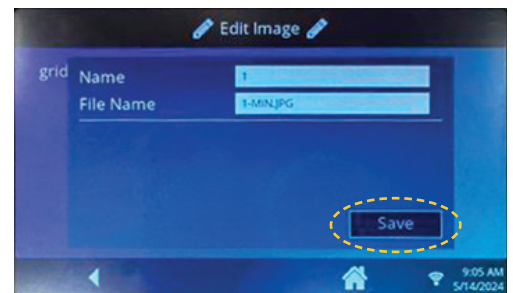

**17.18 Save: To Add Image**

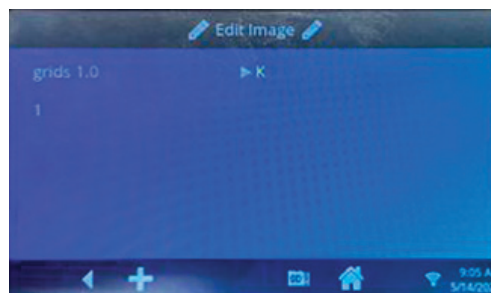

**17.19 Image Selection Screen**



# Operating Instructions

## 5 Edit Image:

To edit an image, touch the edit icon on the left bottom in the image selection screen and select the image to be edited (17.20). This will open the edit window where the image can be moved, rotated (only when image aspect ratio is 1:1) using on-screen arrows, the background color can be changed to black or white (only for images being uploaded using SD card) and user can also choose to make date-time visible in the image (17.21).

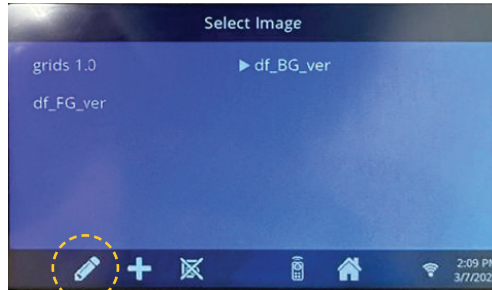

17.20 Edit Image

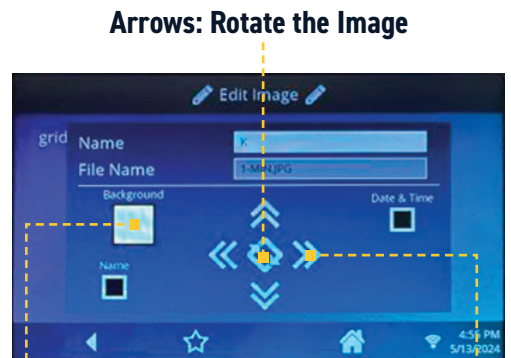

Arrows: Rotate the Image

17.21 Edit Image Window

Background: Black/White

Arrows: Move the Image

## 6 Delete Image:

To delete an image, touch the edit icon and then select the SD card icon on the bottom right (17.22). This will open the list of images stored on the SD card. Select the image to be deleted and then select the "trash" icon on the bottom left and select "Yes" (17.23). NOTE: This will delete the image from the image selection screen and the user will no longer be able to select that image unless image is added again.



17.22 SD Card

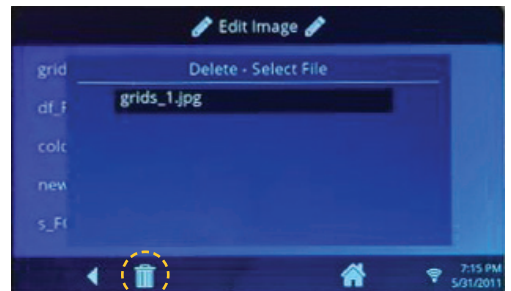

17.23 Trash Icon

## 7 On-Screen Remote:

To use the on-screen remote, touch the remote icon on the right bottom when on the image selection screen. This will open the remote window. The on-screen remote allows the user to control the functions (change source, power on/off, move up/down/left/right, etc.) in the projector (17.24).

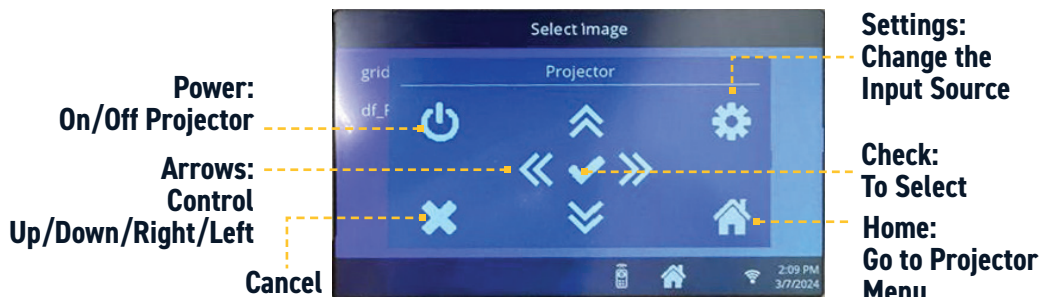

17.24 On-Screen Remote

## Upload and Download

The PPIQ Integrated, once connected to the “Hotronix Cloud”, can be used to upload, download, and calibrate desired image to be projected using the following steps:

**1** Go to the Hotronix Cloud website [www.iq.hotronix.com](http://www.iq.hotronix.com) and login using email and password (18.1).

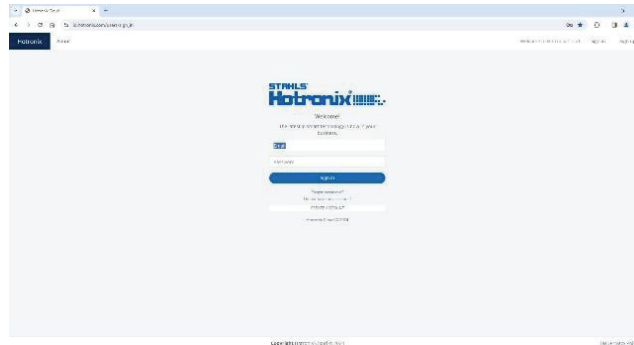

18.1

**2** Go to the “ProPlace IQ” tab on the left panel (18.2) and click on “Start New Layout” for creating a new layout. Users will see a layout with grids on the right side of the screen by default.

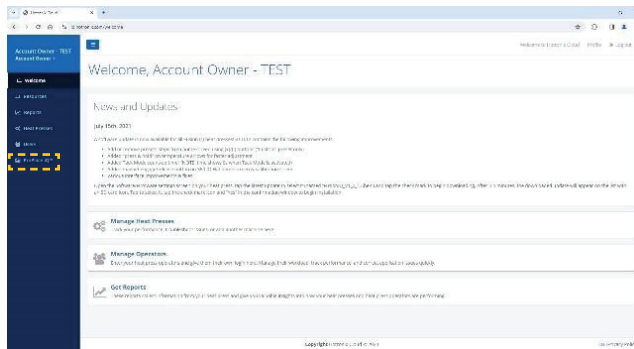

18.2

**3A Edit Mode Tab:** To upload an image, go to the “Upload Image” function under the “Edit Mode” tab and choose the image to be uploaded. The ProPlace IQ tab shows the list of images uploaded (18.3).

**3B** Use the arrows and drop-down menus to resize, move, rotate, delete, and change the image color.

**3C** Click and drag the image to move and grips at the corners to resize the image.

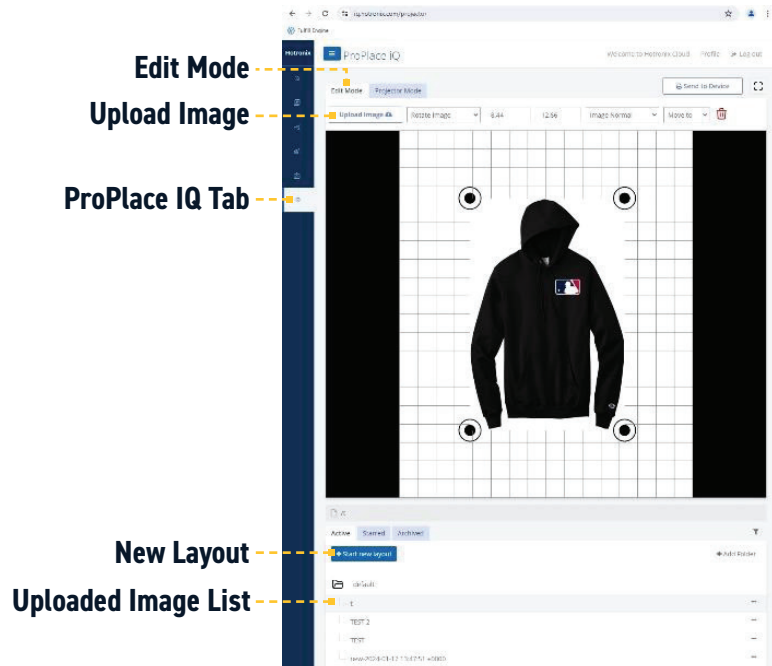

18.3

# Cloud Operations (WIP)

## 4 Projector Mode Tab:

Use the drop-down menus to change the platen size, rotate the background, change the color of the background and toggle grid size (18.4).

5 Click “Send to Device” to open a window that allows the user to choose between “Send” and “Calibrate” tabs (18.5).

6 “Send” tab allows users to select the heat press, which projectors, and resolution settings.

6A Click “Show on Projector” to show the image on selected projector(s) and save the image on the Fusion IQ.

6B Click “Save to Projector” to save the image on the Fusion IQ without showing it on the projector. Note: Users need to manually select the downloaded image from the Fusion IQ screen to project the image (Refer to point #2 on page 30).

7 “Calibrate” tab allows users to calibrate the projected image to desired orientation and alignment. (Refer to “Calibrating the Image” section on next page).

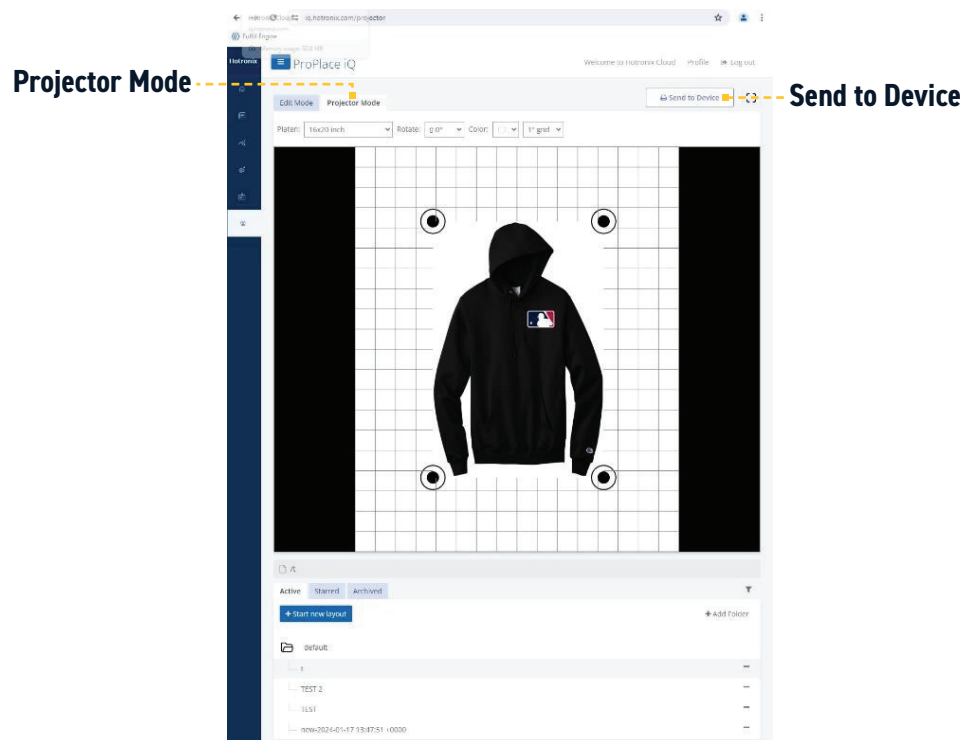

18.4

Select Heat Press where you want to send the image or Calibrate

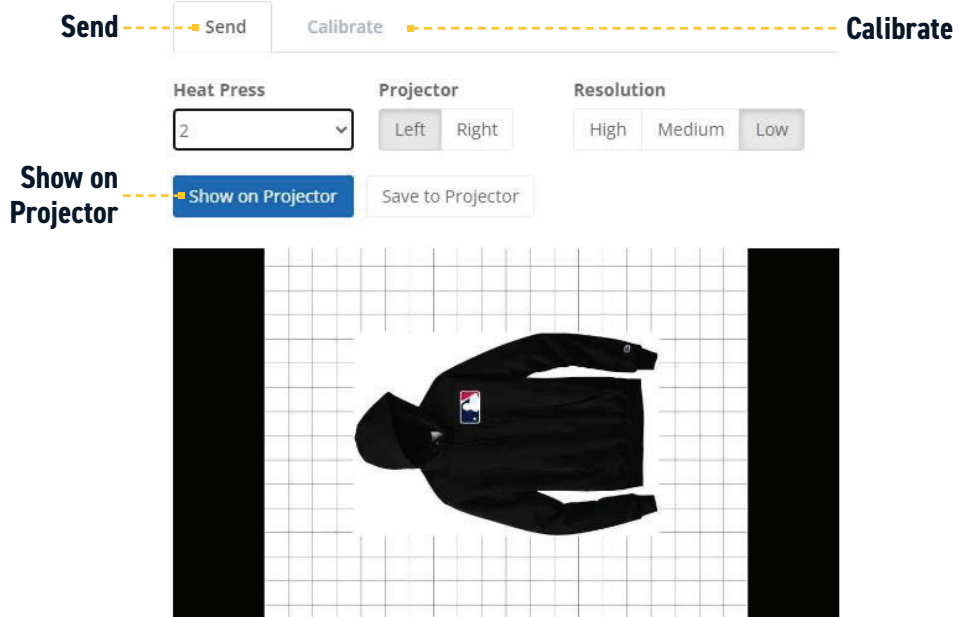

Layout: default/t

18.5

## Calibrating the Image

### 1 Using the “Calibrate” Tab:

In the “Calibrate” tab, users can select the Heat Press first from the drop-down, then select the left or right projector. Enter desired values to scale, rotate, and translate image. Once calibrated, click “Send Calibrating Message” to transfer the settings to the projected image directly (19.1). Note: The changes made here will be saved unless user changes it again.

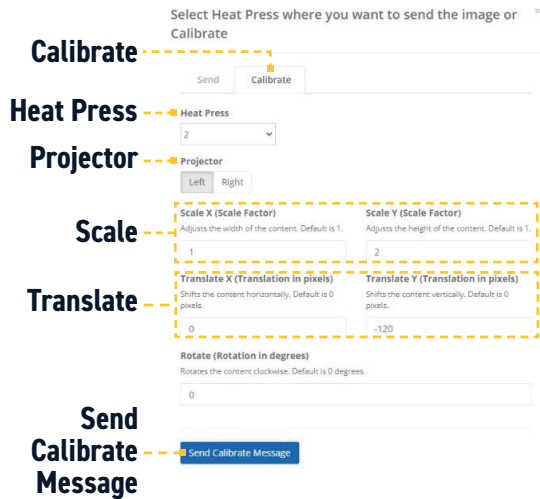

19.1

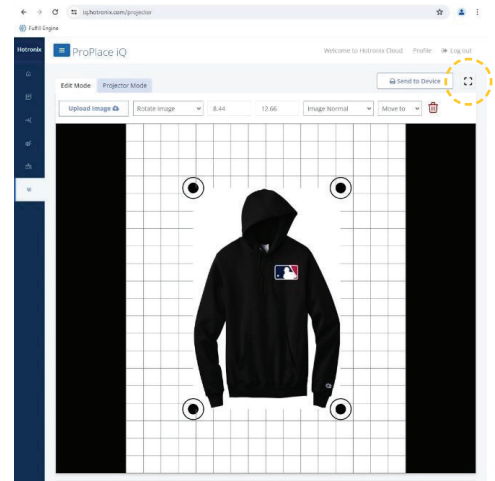

19.2 Full Screen

### 2A Using the “Fullscreen” Mode:

(can be used for Retro and Integrated Versions using HDMI source): Select “Fullscreen Icon” to fit the image to the screen (19.2).

2B Select the gear icon on the top right of the screen to open the settings for calibration (19.3). NOTE: Users can click and drag the image to move and grips at the corners to resize the image.

2C Select the Heat Press first from the drop-down. Use “</>” buttons to scale, rotate, and translate image. Once calibrated, click “Save” (19.4). Note: Clicking on “Save” will just allow the user to save the setting on the Fullscreen and will not reflect the settings into the downloaded image.



19.3 Settings



19.4

# PROPLACE IQ<sup>®</sup>

## Retrofit System

---

**ProPlace IQ<sup>®</sup> Retrofit System** 37-47

**Assembly Instructions** 38-42

**Initial Setup** 43-44

**Operating Instructions** 45-47

**Basic Terminology** 45



# HOTRONIX® PROPLACE IQ® RETROFIT

- 1** Open the back panel unfastening 4 screws using the screwdriver (23.1).



23.1

- 2** Carefully disconnect the fan connector to open the back panel completely (23.2).

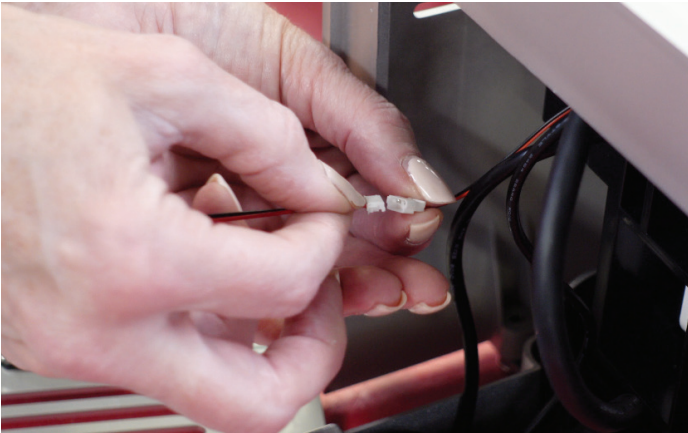

23.2

- 3** Slide the tube into the channel as shown here (23.3).



23.3

- 4** Connect the USB, HDMI, and power cables (x3) protruding out of the tube to the projector (on the accessible height) (23.4).

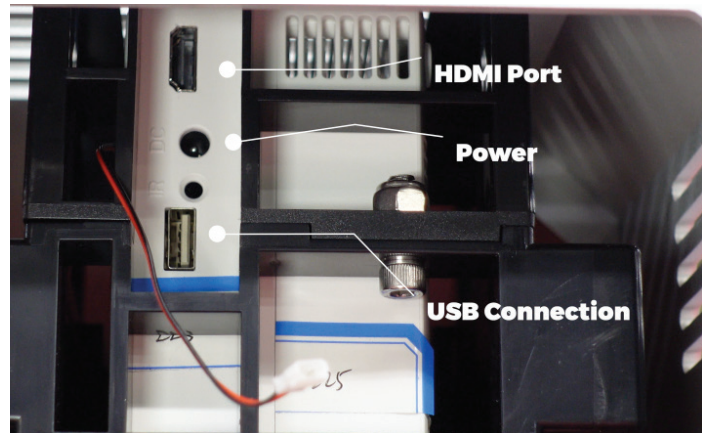

23.4

# Assembly Instructions

5

NOTE: Ensure the connections are tight (23.5).



23.5

7

Close the back panel using 4 screws using the screw driver (23.7).



23.7

6

Reconnect the fan wire to the connector. Note: Ensure to follow the order of the cable by matching the color of the wires (23.6).



23.6

8

Loosely fasten the bolts (x4) to hold the tube and the projector head assembly together. (The bolts will be adjusted in the later step aligning the projector to the platen.) (23.8)



23.8

# HOTRONIX® PROPLACE IQ® RETROFIT

- 9** Take the laser wire out of the tube gently. The connector end has to remain plugged in to the PI board (23.9).



23.9

- 11** Align the tube with the bottom channel and place the tube sliding into the channel. NOTE: Ensure the laser wire doesn't get pinched between the tubes (23.11).



23.11

- 10** Have someone hold the projector assembly in place. Plug in the two laser wires (in any of the two ports) to the connector plug (23.10).



23.10

- 12** Place the washer and fasten the bolts on both the sides of the tube using the supplied wrench. (23.12).



23.12



# Assembly Instructions

- 13** Repeat steps 1 through 12 on the other side (tube and projector assembly).

- 14** Place the washer and loosely fasten the bolts (1 on each side) on the outer side of the tube (23.13).



23.13

- 15** Carefully slide the support bracket connecting the tubes so that the washer and the bolts hold the support bracket (23.14).



23.14

- 16** Fasten the bolts (x2) on both the tubes holding the support bracket in place using the supplied wrench (23.15, 23.16).

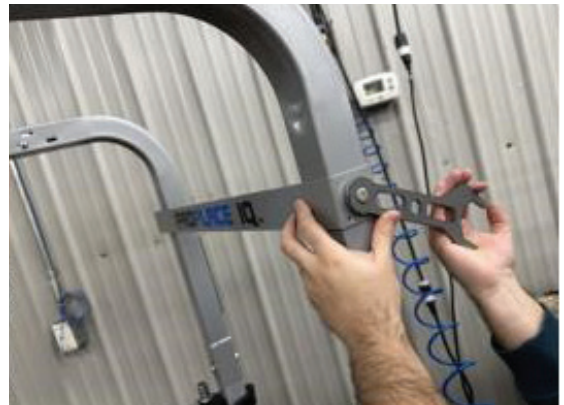

23.15



23.16

**17** Peel the protective film out from both the sides of the transparent cover (23.17, 23.18). **NOTE:** Before installing the transparent cover, make sure the focus is adjusted on both projectors as outlined in the Initial Setup section on pages 49-50, then complete steps 18-19.



**23.17**



**23.18**

**18** Slide the transparent cover through the slot on the side of the housing. Ensure it rests completely on the ribs of the housing all the way until it rests on the ribs on the other side (23.19, 23.20).



**23.19 Transparent Cover**



Transparent Cover Resting on Rib  
Slot for Transparent Cover

**23.20**

**19** Align the holes in the transparent cover with the holes on the lip of the mounting base and fasten the two using 8-32 thumb screw (qty. 2) and using fingers (23.21, 23.22).

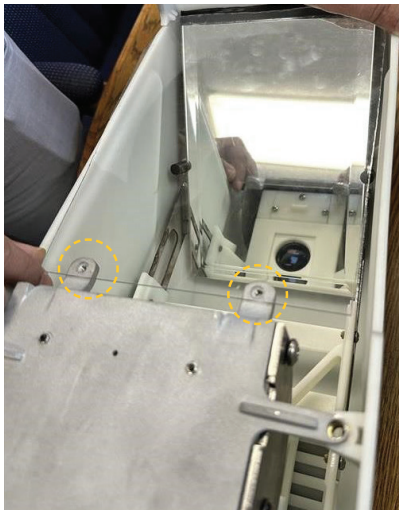

**23.21 Aligning the Holes**



**23.22**

# Initial Setup

**20** Plug in the supplied power cord to the PI board externally (on both right and left support tubes) (23.23).



23.23

**21** Plug in the adapter end of the supplied power cord to a 120 V power strip or wall outlet. (23.24).



23.24

## Initial Setup

**1** Turn on the machine to adjust the focus on both the projectors ensuring crisp image. To adjust the focus, just turn the lens on the right side of the projector when viewed from the front of the machine (24.1, 24.2).



24.1



24.2

**2** Ensure that the source on the projector is set to HDMI (topmost function from the dropdown) by default when we turn the projector on for the first time for HDMI and Cloud functionality (24.3, 24.4).

**3** Use the supplied remote to change the source on the projector. Press this button to change the source (24.5).

**4** Go to the “Menu” settings. Ensure the “flip” on the projector is set to “Back Table” when you turn the projector on for the first time (24.6, 24.7).

**5** Use the supplied remote to go to the menu on the projector. Press this button to see the menu (24.8).

**6** Place the transparent cover to cover/close the housing from underneath (follow steps 17-19 in the previous Assembly Instructions section).

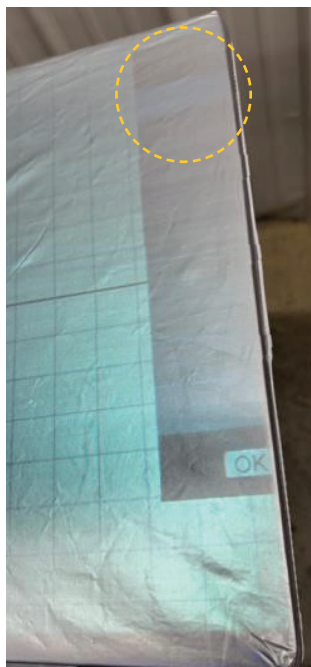

**24.3 HDMI Source Selected**



**24.4**



**24.5**



**24.6**



**24.7**

# Operating Instructions

**7** Calibrate the x and y per requirement using the mechanical adjustment knobs (5/16"-18 Screws) for rotation and translation using the supplied 3/16 Hex Alan Key. Left screw is for adjusting the rotation (24.9) and Right screw is for adjusting the translation (24.10) when viewing from the front of the machine. NOTE: Do not force tighten/fasten the adjustment knobs as it might damage the internal mechanism.



**24.8**



**24.9 Right screw:  
To adjust translation**

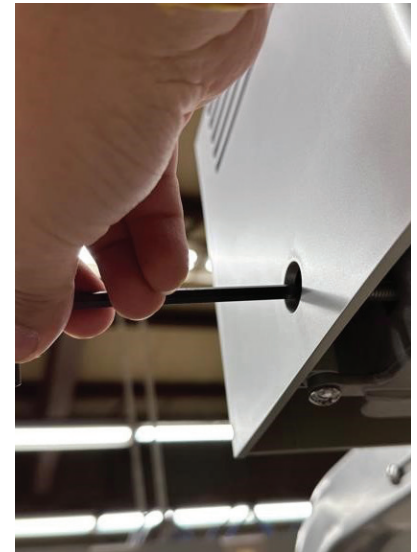

**24.10 Left screw:  
To adjust rotation**

**8** Use software (Hotronix Cloud) to calibrate even further if needed (Page 36, "Calibrating the Image").

**9** Ensure that the Fusion IQ and the computer connected to the cloud and/or via HDMI are synced to the same time zone.

## Operating Instructions - Basic Terminology



# HOTRONIX® PROPLACE IQ® RETROFIT

## 1 Initial Check:

Touch the setup menu icon on the home screen (25.1) and touch “System”. Ensure the screen has “Projector” checked and “Retro” selected (not network), and the laser icon is visible on the right bottom (25.2). NOTE: If the “Projector” Icon is not checked, check the box and then user will be asked to restart the system by selecting “Yes” (25.3).



25.1 Setup Menu

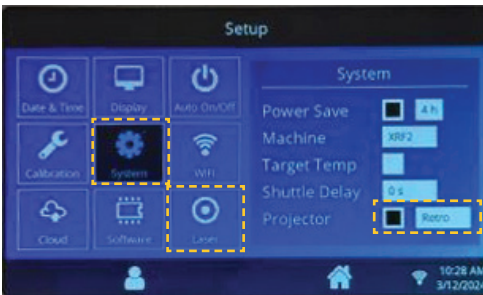

25.2 Projector and Retro “Checked”



25.3

## 2A Calibrating Lasers:

Touch the laser icon on the center bottom. This will open the laser calibration window (25.4). When the shuttle is at the right station, the calibration can be done to the left station projector (A on the laser setup screen). To calibrate it, start by touching on to “1” twice (one touch will toggle “on” the “1” and second touch will toggle “off” the “1”) and check if the projector lamp on the left station turns “off” or not. If it does, then touch “1” third time to check if the lamp on the projector is turned “on” or not. NOTE: Turning lamp “on” implies that the projector shows the same screen as it was showing before without having to restart the projector. Turning projector “on” implies that the projector restarts from beginning (showing “smart projector” at startup). Repeat the same step by choosing “2”, “3” and “4” until the user finds the one that turns “on/off” the projector lamp (25.5, 25.6). Once that is confirmed, turn the toggle to “on” position on the same number and then hit the check mark on the center bottom to finish the calibration (25.7). NOTE: Allow some time between the first, second and third touch.



25.4

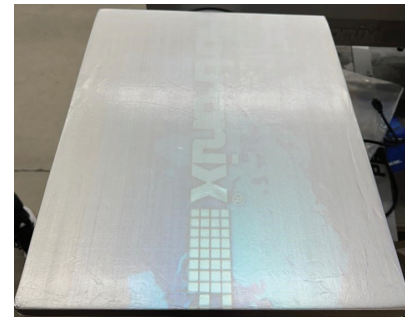

25.5 Projector Lamp “On”

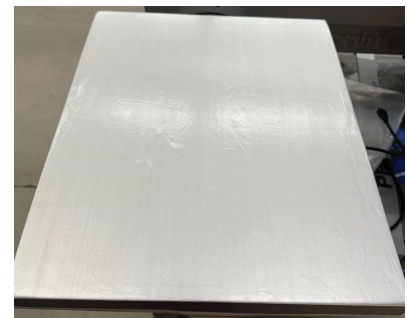

25.6 Projector Lamp “Off”



25.7

# Operating Instructions

**2B** Repeat step 2A to calibrate the right station. Ensure to use B to calibrate the right-station laser and the shuttle is shifted all the way to the left station.

## 3 USB to Project an Image:

Plug in the USB drive containing images to the PI board (25.8). Using the supplied remote controller, change the source to media (25.9) (second option on the drop down (25.10) and then go to photos (25.11), "c drive" (25.12), and select the desired image to project from the list (25.13).

## 4 HDMI to Project an Image:

Plug in one end of the HDMI cable to the PI board (25.14) and another end to a device (computer/laptop/tablet). Using the supplied remote controller, change the source to HDMI (first option on the drop down) (25.15). This should mirror the screen on your device to the platen. Open an image on the device so that the projector mirrors that image onto the platen.



25.8



25.9  
Change the Source

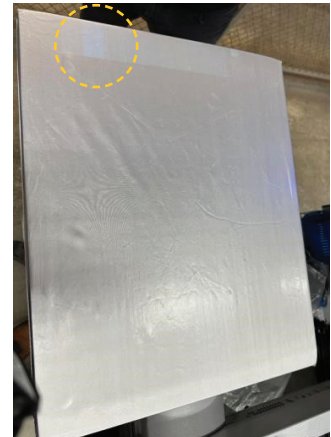

25.10  
Second Option for Selecting Media

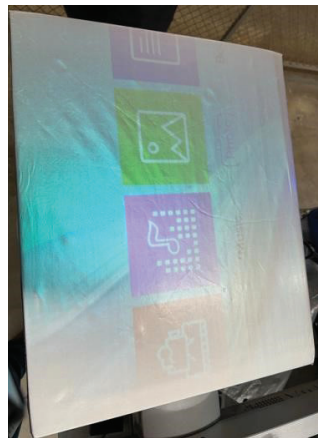

25.11 Select Photo

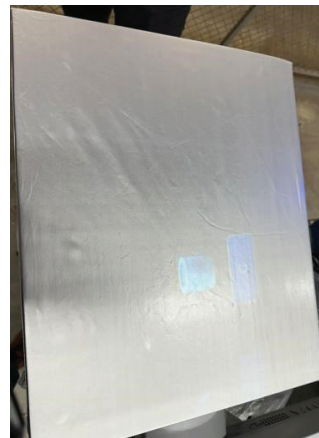

25.12 C Drive



25.13 Image Selection Screen



25.14

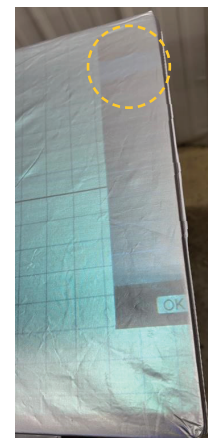

25.15  
First Option for Selecting HDMI

# HOTRONIX® PROPLACE IQ®

ITEM #	PART NAME	PART #	QTY
179	ProPlace IQ Support Tube/Frame	4-1188	1
	ProPlace Retro Laser Wire	1-2672	1
180	ProPlace IQ Mounting Base	1-2673	2
181	ProPlace IQ Mini Rail (Pairs)	1-2674	2
182	ProPlace IQ Gear Box	1-2675	2
183	ProPlace IQ Gear Rack	1-2676	2
184	ProPlace IQ Spacer	1-2677	4
185	ProPlace IQ Rack Cover	1-2678	2
186	ProPlace IQ Side Plate	1-2679	2
187	ProPlace IQ Projector Box	1-2680	2
188	ProPlace IQ Holding Fork	1-2681	2
189	ProPlace IQ Mirror Bracket	1-2682	2
190	ProPlace IQ Mirror	1-2683	2
191	ProPlace IQ Mirror Holder	1-2684	4
192	ProPlace IQ Projector	1-2685	2
	Remote Control for projector	1-2686	1
193	ProPlace IQ Projector Cover	1-2687	2
194	ProPlace IQ Housing	1-2688	2
195	ProPlace IQ Transparent Cover	1-2689	2
196	ProPlace IQ Back Panel	1-2690	2
197	ProPlace IQ Fan	1-2691	2
198	ProPlace IQ Filter Bracket	1-2692	2
199	ProPlace IQ Filter Mesh	1-2693	2
201	ProPlace IQ PI BOX LOWER HALF	1-2694	2
202	ProPlace IQ PI BOX UPPER HALF	1-2695	2
203	ProPlace IQ PI BOX UPPER HALF-(Stand alone)	1-2696	2
204	Button Head Hex Drive Screw, Black-Oxide Alloy Steel, 3-56 Thread, 5/16" Long	3-1011-289	14
205	Screw-Mount Nut, Steel, 5/16"-18 Thread, 0.375" Diameter x 3/8" High Barrel	2-1006-122	4
206	Steel Rounded Head Thread-Forming Screws for Brittle Plastic, Black Zinc-Plated, Number 4 Size, 5/16" Long	3-1011-290	14
207	18-8 Stainless Steel Button Head Hex Drive Screw, 5/16"-18 Thread Size, 2-1/4" Long	3-1011-291	2
208	18-8 Stainless Steel Button Head Hex Drive Screw, 5/16"-18 Thread Size, 2-1/2" Long	3-1011-292	2
209	Hollow-Lock Set Screw, Black-Oxide Alloy Steel, 1/4"-20 Thread, 1/8" Long	3-1011-293	4
210	Passivated 18-8 Stainless Steel Pan Head Phillips Screw, 8-32 Thread, 3/8" Long	3-1011-294	32
212	Low-Strength Steel Nylon-Insert Locknut, Zinc-Plated, 8-32 Thread Size	2-1006-123	8
213	Passivated 18-8 Stainless Steel Pan Head Phillips Screw, 8-32 Thread Size, 11/16" Long	3-1011-295	8
214	Passivated 18-8 Stainless Steel Pan Head Phillips Screw, 1/4"-20 Thread, 3/8" Long	3-1011-296	8
215	Mil. Spec. Alloy Steel Socket Head Screw, 1/4"-20 Thread Size, 3/4" Long	3-1011-297	2
216	Low-Strength Steel Nylon-Insert Locknut, Zinc-Plated, 1/4"-20 Thread Size	2-1006-124	2
217	Passivated 18-8 Stainless Steel Pan Head Phillips Screw, 1/4"-20 Thread, 1/2" Long	3-1011-298	16
218	Plastic-Head Thumb Screw with Hex Drive, 8-32 Thread Size, 9/32" Long	1-2200	4
219	Passivated 18-8 Stainless Steel Pan Head Phillips Screw, 6-32 Thread, 1" Long	3-1011-299	8
220	Mil. Spec. Low-Strength Steel Hex Nut, 6-32 Thread Size, MS35649-262	2-1006-125	8
221	91090A115/ THE 1" WASHER Zinc-Plated Steel Oversized Washer	2-1006-126	6
222	Zinc Yellow-Chromate Plated Hex Head Screw, Grade 8 Steel, 3/8"-16 Thread Size, 7/8" Long	3-1011-300	6
223	Phillips Rounded Head Thread-Forming Screws for Plastic, 18-8 Stainless Steel, Number 4 Size, 1/4" Long	3-1011-301	6
224	Rounded Head Thread-Forming Screws for Brittle Plastic, 18-8 Stainless Steel, Number 6 Size, 3/4" Long	3-1011-302	8
225	Screw, Pan Phillips #4-40 x 1"	3-1011-130	4
226	Standoff, #4-40 x 5/16" Aluminum 1/4" Hex	1-2073	4
227	ProPlace IQ Connector Plug	1-2697	2
228	F-IQ PRJCTR HDMI	1-2666	2
229	PRJCTR INTRFCE SPLITTER	1-2667	1



# Replacement Parts List & Parts Location Guide

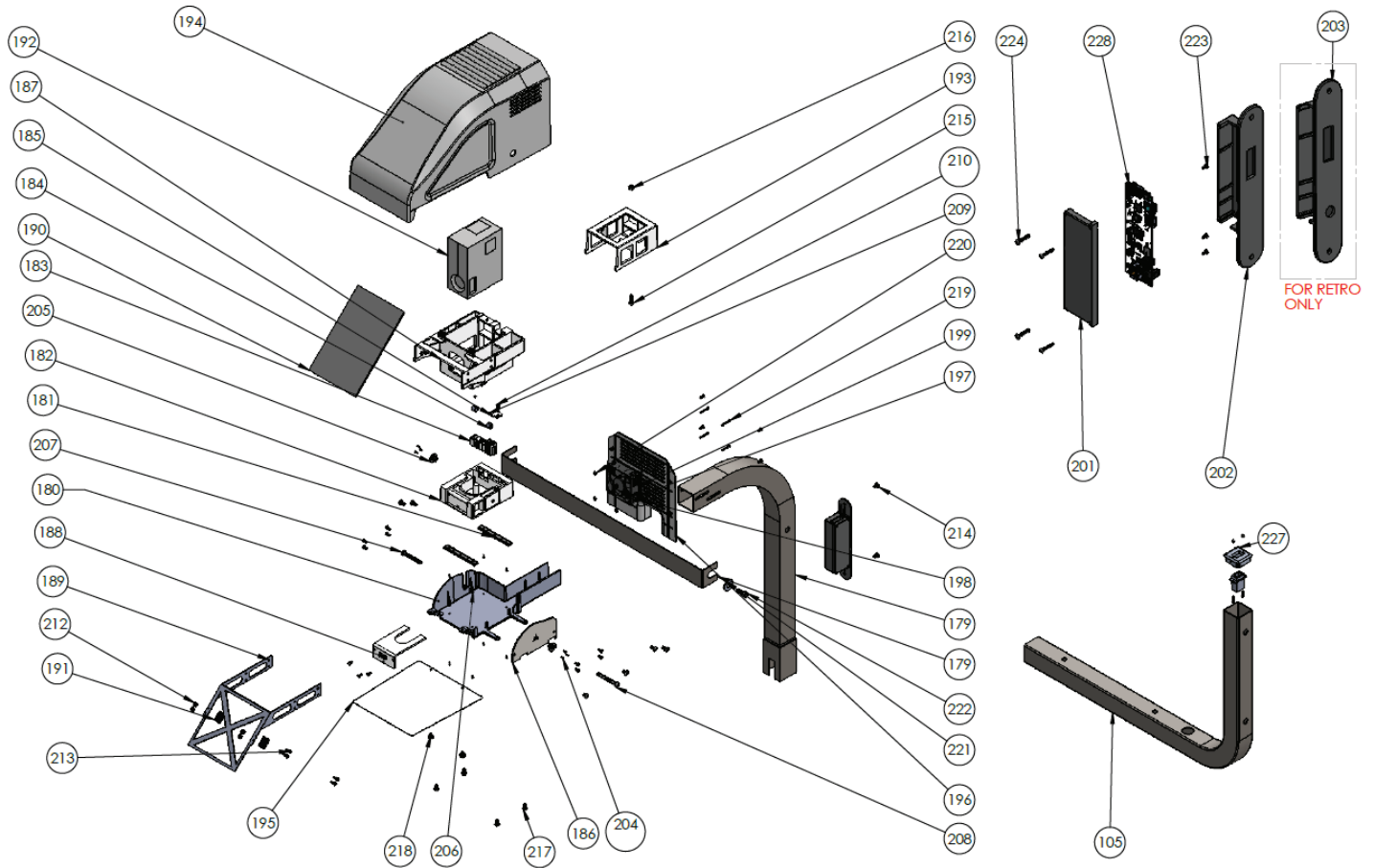

ITEM #	PART NAME	PART #	QTY
	ProPlace IQ Wire Kit	1-2698	1
	Power adapter	1-2699	2
	ProPlace IQ WRENCH FOR 9/16" AND 1-7/8"	1-2700	1
	ProPlace IQ ALLEN WRENCH FOR ADJUSTMENT KNOBS (HEX, DRIVE SIZE 3/16")	1-2701	1
	LABEL, PROPLACE IQ HOUSING; SET	1-2669	1
	LABEL, PROPLACE IQ LOGO BAR	1-2670	1
	LABEL, PROPLACE IQ FRONT HOUSING 3PC	1-2671	1
	PPIQ BOX	1-2702	1
	PPIQ FOAM	1-2703	1



# FIRMWARE UPDATES

## Integrated & Retrofit Systems

---

**Firmware Updates** [51-57](#)

**IQ Firmware Updates Using SD Card** [52-53](#)

**HDMI PI Firmware Updates** [54-57](#)

Option 1: Using IQ Controller SD Card [54-55](#)

Option 2: Using HDMIPi Board SD Card [56-57](#)



# HOTRONIX® FIRMWARE UPDATES

**1** Pop out the front face carefully by inserting a paper clip in small holes on both the side of the fusion cover. (20.1) Disconnect the front face carefully from the power board. Take out the SD card from the fusion IQ board (20.2).



20.1



20.2

SD Card

**2** Plug in the SD card to a computer and upload the latest firmware files to the "FirmwareUpdate" folder in the SD card (20.3).

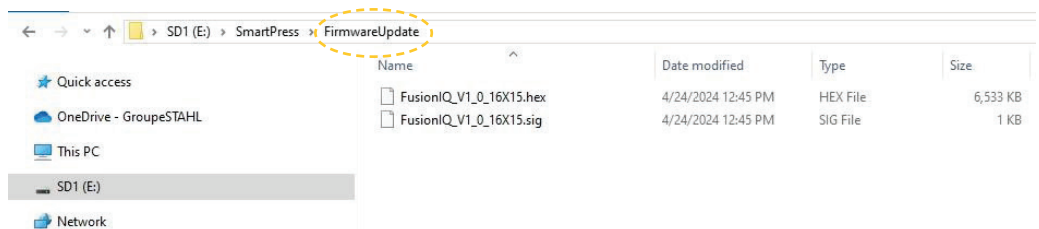

20.3 Firmware Update Folder

**3** Plug in the SD card back to the Fusion IQ board and carefully plug the fusion IQ board to the power board. Turn on the machine. On the Fusion IQ home screen, click on the "Setup Menu" (20.4) and then select "Software" (20.5) to open the software list.



20.4 Setup Menu



20.5 Software

# IQ Firmware Updates Using SD Card

**4** Select the desired firmware from the list (20.6) and then press on the check mark icon (20.7) and press “Yes” to confirm (20.8). Wait for the Fusion IQ to finish rebooting (20.9).



20.6 Software List

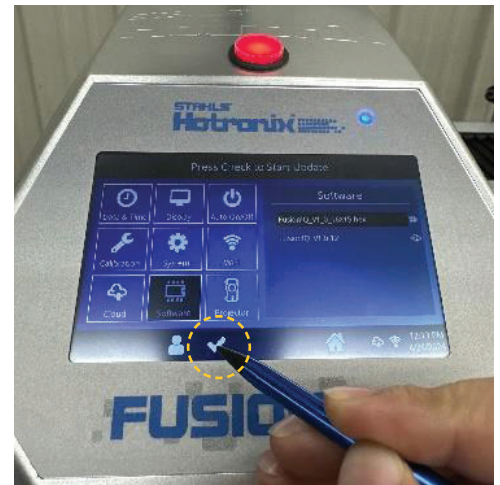

20.7 Checkmark



20.8



20.9

# HOTRONIX® FIRMWARE UPDATES

## Option 1: Using IQ Controller SD Card

**1** Pop out the front face carefully by inserting a paper clip in small holes on both the side of the fusion cover. (21.1) Disconnect the front face carefully from the power board. Take out the SD card from the Fusion IQ board (21.2).



21.1

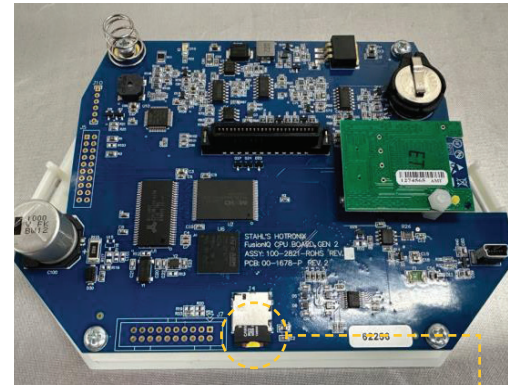

21.2

**2** Plug in the SD card to a computer and upload the latest firmware files to the "FirmwareUpdate" folder in the SD card (21.3).

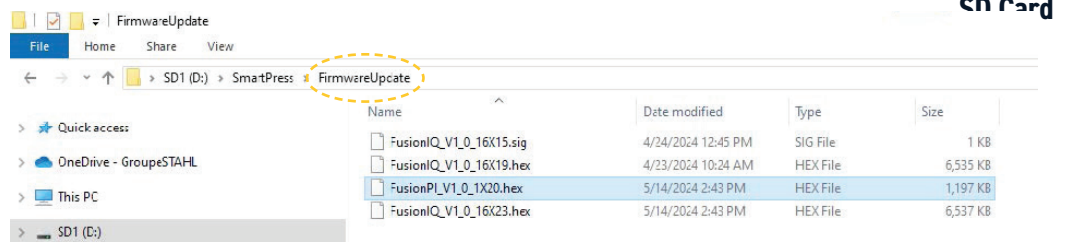

21.3 Firmware Update Folder

**3** Plug in the SD card back to the Fusion IQ board and carefully plug the Fusion IQ board to the power board. Turn on the machine. On the Fusion IQ home screen, click on the "Setup Menu" (21.4) and then select "Software" (21.5) to open the software list.

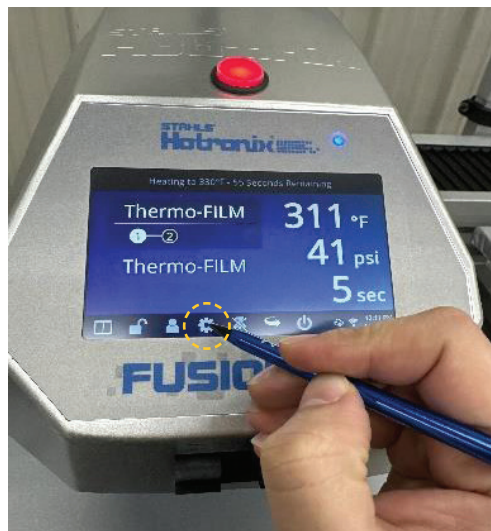

21.4 Setup Menu



21.5 Software

# HDMI PI Firmware Updates

**4** Once this file is on the FusionIQ SD Card in the Firmware Update directory it will be listed on the Software Setup screen with a SD Card icon shown (21.6). Select the desired firmware from the list and then press on the check mark icon (21.7) and press “Yes” to confirm (21.8). Do not turn off, wait for update.



**21.6 Software List**

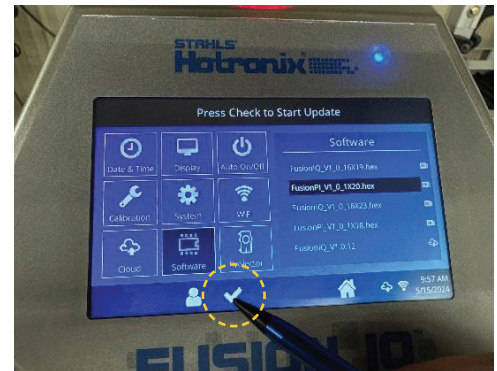

**21.7 Checkmark**

**5** When successfully started the FusionPI firmware file will be removed from the list and all projectors on the network will display the Firmware Update status screen. The Firmware Update status screen will be a blue background with text displayed indicating Firmware Update progress (21.9). Once the Preparing Update process has completed, the FusionPI will restart and begin the installation process. While the installation process is occurring the projector screen will be black/blank and after a timeout the Projector will show the “No Signal” message on screen. **Make sure to wait for the process to finish (expected to take around 10 min).**

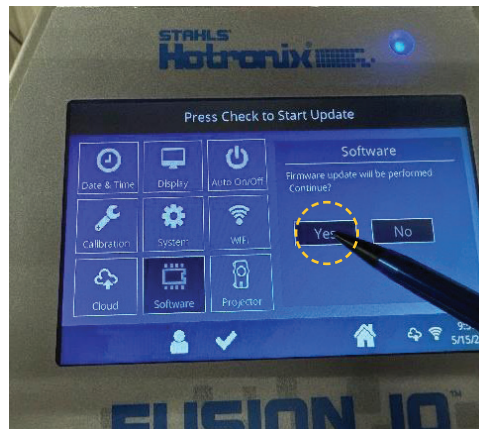

**21.8**



**21.9**

# HOTRONIX® FIRMWARE UPDATES

## Option 2: Using HDMI PI Board SD Card

**1** Turn the machine off. Using a screwdriver, take both PI Boxes off and open it to get access to the HDMI PI boards (22.1, 22.2). Take out the SD cards from the HDMI PI boards (22.3).

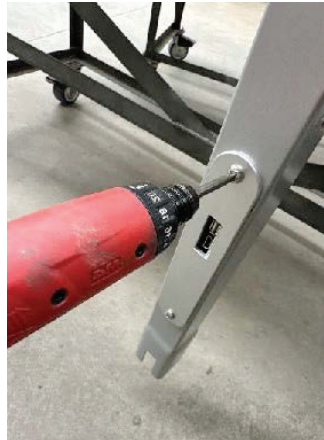

22.1



22.2

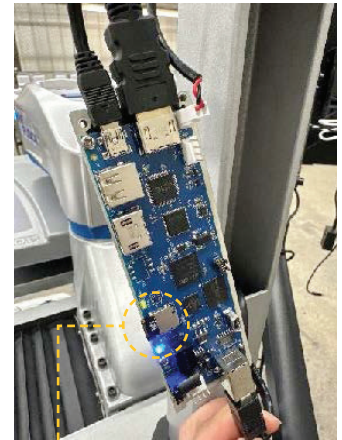

22.3  
SD Card

**2** Plug in the SD cards to a computer and upload the latest firmware files to the "FirmwareUpdate" folder in the SD cards (22.4). **Make sure this is done for both sides.**

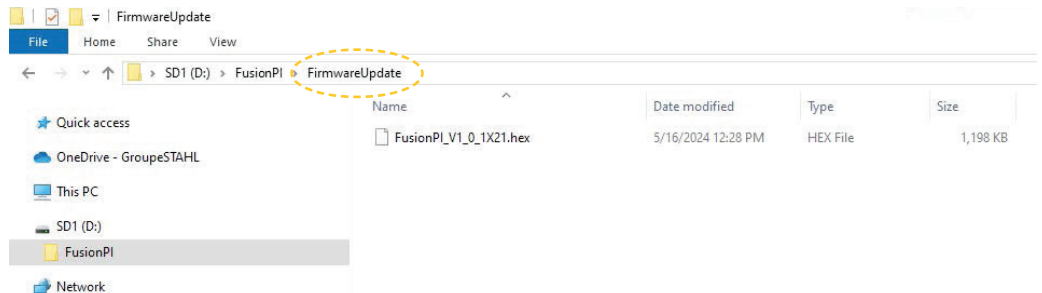

22.4 Firmware Update Folder

**3** Plug in the SD card back to the HDMI PI Board and install the HDMI PI board back. Turn on the machine. On the Fusion IQ home screen, click on the "Setup Menu" (22.5) and then select "Software" (22.6) to open the software list.



22.5 Setup Menu



22.6 Software



# HDMI PI Firmware Updates

**4** Once this file is on the HDMI PI Board SD Card in the Firmware Update directory it will be listed on the Software Setup screen with a Projector icon shown (22.7). Select the desired firmware from the list and then press on the check mark icon (22.8) and press “Yes” (22.9) to confirm. Do not turn off, wait for update.

**5** When successfully started the FusionPI firmware file will be removed from the list and all projectors on the network will display the Firmware Update status screen. The Firmware Update status screen will be a blue background with text displayed indicating Firmware Update progress (22.10). If a HDMI PI board does not have the selected firmware update file installed on its SD Card, then the Firmware Update progress screen will be shown briefly and the FusionPI board will reboot without completing a firmware update. The FusionPI boards will begin updating simultaneously. A black background screen is displayed with the Preparing Update status text displayed. Any HDMI PI board not completing the firmware update will not show the Preparing Update status screen. Once the Preparing Update process has completed, the FusionPI will restart and begin the installation process. While the installation process is occurring the projector screen will be black/blank and after a timeout the Projector will show the “No Signal” message on screen. **Make sure to wait for the process to finish (expected to take around 5 min).**



22.7 Software List

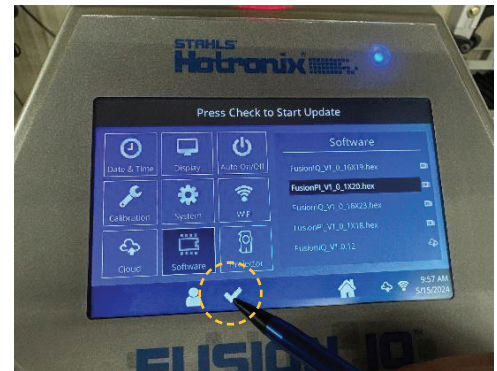

22.8 Checkmark

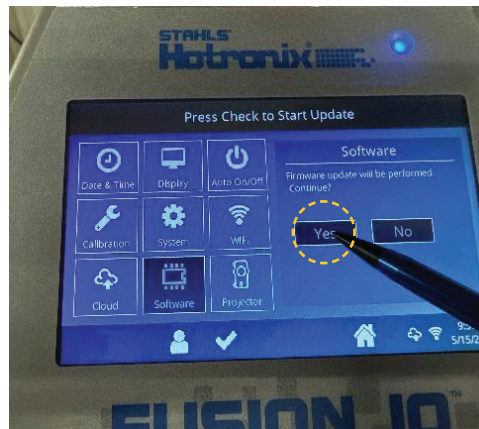

22.9



22.10

# CONTACT US

## **STAHL'S Hotronix®**

One Industrial Park  
Carmichaels, PA 15320  
U.S.A.

## **Technical Support**

[hotronix.com/support](https://hotronix.com/support)

## **Customer Service**

[customerservice@hotronix.com](mailto:customerservice@hotronix.com)

## **Replacement Parts**

[hotronix.com/locationspart](https://hotronix.com/locationspart)

